

名称 Name	型号 Profile No.	壁厚 Thickness	单重(kg/m) Weight
20*20U	GYC46021		0.46

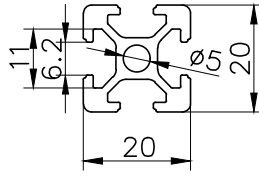

名称 Name	型号 Profile No.	壁厚 Thickness	单重(kg/m) Weight
20*20U	HJG-2512	1.5	0.463

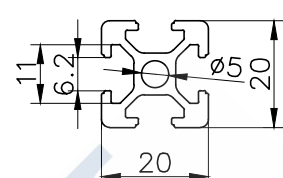

名称 Name	型号 Profile No.	壁厚 Thickness	单重(kg/m) Weight
20*20U	GYC46126	1.5	0.463

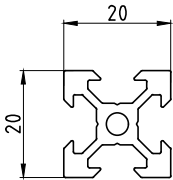

名称 Name	型号 Profile No.	壁厚 Thickness	单重(kg/m) Weight
2020A型材	GYC46307		0.465

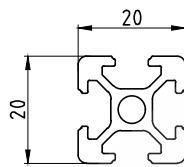

名称 Name	型号 Profile No.	壁厚 Thickness	单重(kg/m) Weight
2020型材	GYC46306		0.462

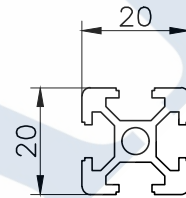

名称 Name	型号 Profile No.	壁厚 Thickness	单重(kg/m) Weight
20*20U	GYC46185		0.465

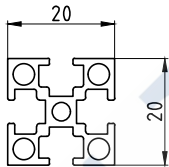

名称 Name	型号 Profile No.	壁厚 Thickness	单重(kg/m) Weight
支架	GYC-JZ104		0.406

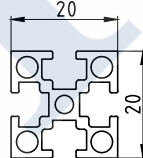

名称 Name	型号 Profile No.	壁厚 Thickness	单重(kg/m) Weight
支架	GYC-JZ103		0.415

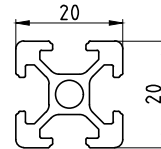

名称 Name	型号 Profile No.	壁厚 Thickness	单重(kg/m) Weight
流水线支架	GYC46359		0.450

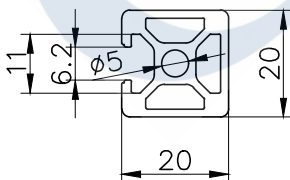

名称 Name	型号 Profile No.	壁厚 Thickness	单重(kg/m) Weight
20*20U	GYC46077	1.5	0.533

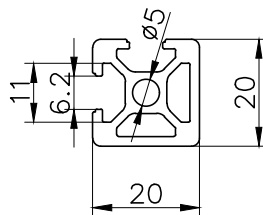

名称 Name	型号 Profile No.	壁厚 Thickness	单重(kg/m) Weight
20*20U	GYC46078	1.8	0.528

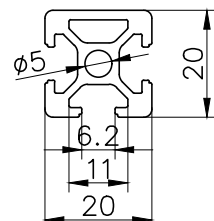

名称 Name	型号 Profile No.	壁厚 Thickness	单重(kg/m) Weight
20*20U	GYC46079	1.8	0.496

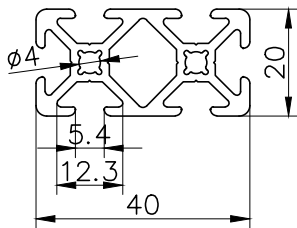

名称 Name	型号 Profile No.	壁厚 Thickness	单重(kg/m) Weight
20*40U	GYC46022		0.819

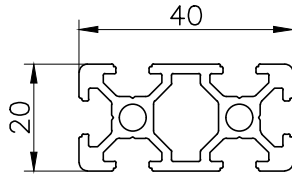

名称 Name	型号 Profile No.	壁厚 Thickness	单重(kg/m) Weight
40*20U	GYC46188		0.803

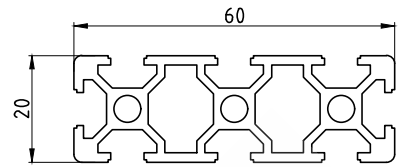

名称 Name	型号 Profile No.	壁厚 Thickness	单重(kg/m) Weight
支架	GYC-JZ003		1.134

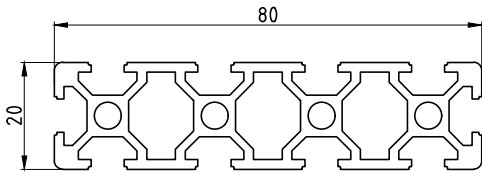

名称 Name	型号 Profile No.	壁厚 Thickness	单重(kg/m) Weight
支架	GYC-JZ004		1.491

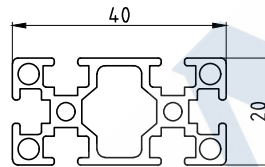

名称 Name	型号 Profile No.	壁厚 Thickness	单重(kg/m) Weight
支架	GYC-JZ105	1.4	0.722

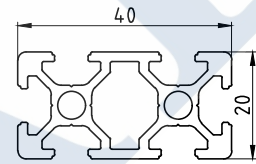

名称 Name	型号 Profile No.	壁厚 Thickness	单重(kg/m) Weight
流水线支架	GYC46360		0.783

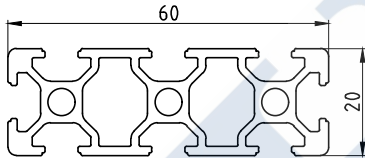

名称 Name	型号 Profile No.	壁厚 Thickness	单重(kg/m) Weight
流水线支架	GYC46363		1.11

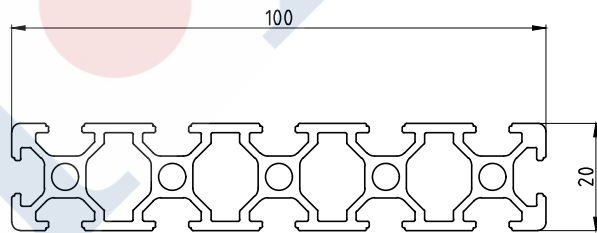

名称 Name	型号 Profile No.	壁厚 Thickness	单重(kg/m) Weight
流水线支架	GYC46391		1.79

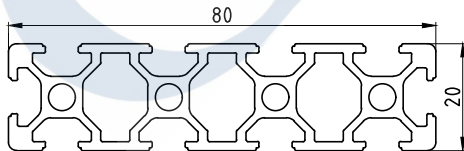

名称 Name	型号 Profile No.	壁厚 Thickness	单重(kg/m) Weight
流水线支架	GYC46390		1.456

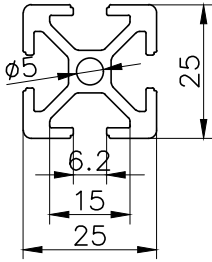

名称 Name	型号 Profile No.	壁厚 Thickness	单重(kg/m) Weight
25*25U	GYC46081	2.0	0.7

CH·AL

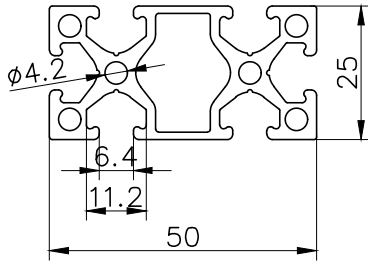

名称 Name	型号 Profile No.	壁厚 Thickness	单重(kg/m) Weight
20*50U	GYC46080	1.4	1.166

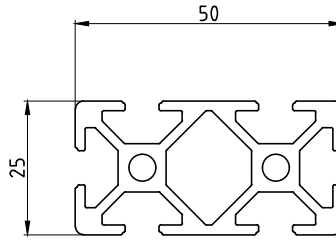

名称 Name	型号 Profile No.	壁厚 Thickness	单重(kg/m) Weight
支架	GYC-JZ088		1.241

CH·AL

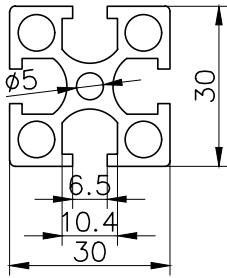

名称 Name	型号 Profile No.	壁厚 Thickness	单重(kg/m) Weight
30*30G	GYC46004		0.969

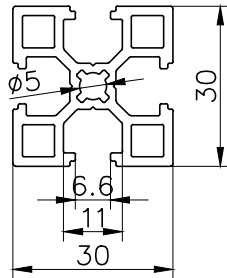

名称 Name	型号 Profile No.	壁厚 Thickness	单重(kg/m) Weight
30*30G	GYC46036		0.869

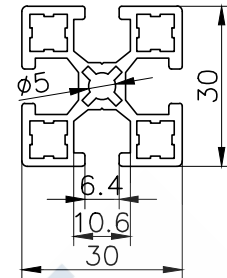

名称 Name	型号 Profile No.	壁厚 Thickness	单重(kg/m) Weight
30*30G	GYC46041		0.805

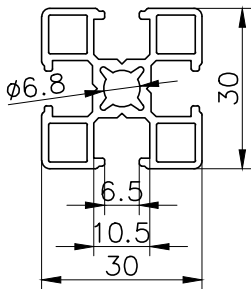

名称 Name	型号 Profile No.	壁厚 Thickness	单重(kg/m) Weight
30*30G	GYC46072		0.726

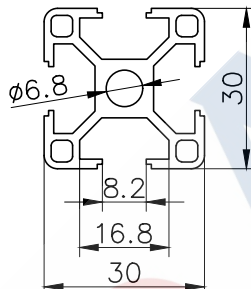

名称 Name	型号 Profile No.	壁厚 Thickness	单重(kg/m) Weight
30*30U	GYC46076		0.771

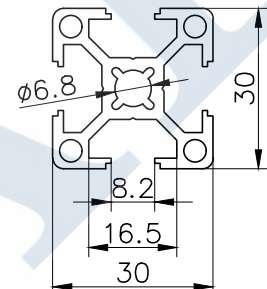

名称 Name	型号 Profile No.	壁厚 Thickness	单重(kg/m) Weight
30*30U	GYC46082		0.826

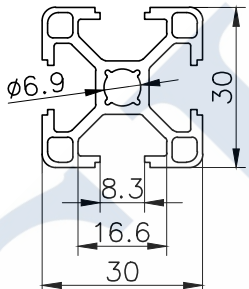

名称 Name	型号 Profile No.	壁厚 Thickness	单重(kg/m) Weight
30*30U	GYC46063		0.71

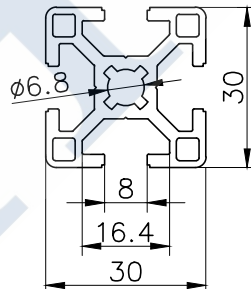

名称 Name	型号 Profile No.	壁厚 Thickness	单重(kg/m) Weight
30*30U	HJG-926		0.889

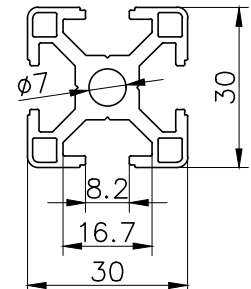

名称 Name	型号 Profile No.	壁厚 Thickness	单重(kg/m) Weight
30*30U	GYC46034		0.871

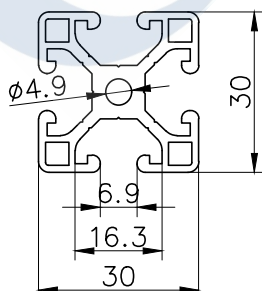

名称 Name	型号 Profile No.	壁厚 Thickness	单重(kg/m) Weight
30*30U	GYC46023		0.871

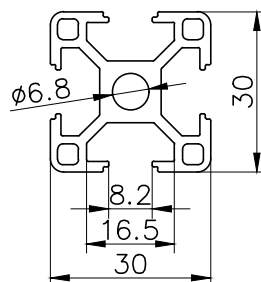

名称 Name	型号 Profile No.	壁厚 Thickness	单重(kg/m) Weight
30*30U	GYC46127	2.0	0.842

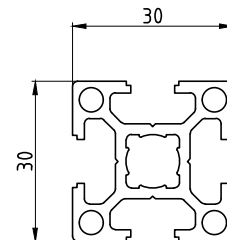

名称 Name	型号 Profile No.	壁厚 Thickness	单重(kg/m) Weight
30*30U	GYC46170		0.857

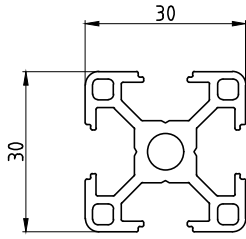

名称 Name	型号 Profile No.	壁厚 Thickness	单重(kg/m) Weight
30*30U	GYC46233		0.841

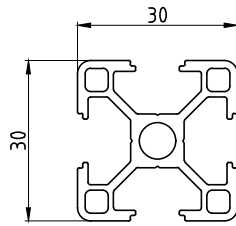

名称 Name	型号 Profile No.	壁厚 Thickness	单重(kg/m) Weight
支架料	GYC46266	1.45	0.712

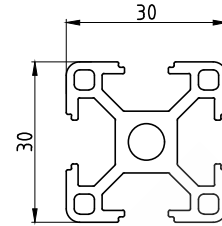

名称 Name	型号 Profile No.	壁厚 Thickness	单重(kg/m) Weight
3030型材	GYC46309	1.5	0.885

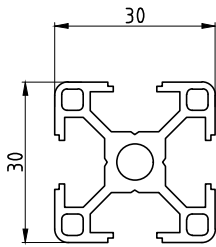

名称 Name	型号 Profile No.	壁厚 Thickness	单重(kg/m) Weight
3030C型材	GYC46308		0.786

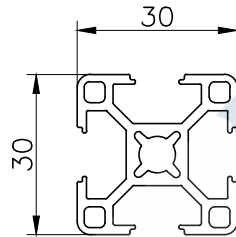

名称 Name	型号 Profile No.	壁厚 Thickness	单重(kg/m) Weight
30*30U	GYC46186		0.776

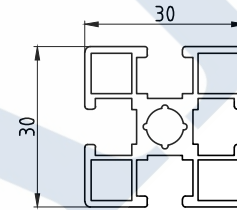

名称 Name	型号 Profile No.	壁厚 Thickness	单重(kg/m) Weight
支架	GYC46296	0.9	0.71

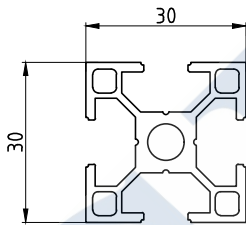

名称 Name	型号 Profile No.	壁厚 Thickness	单重(kg/m) Weight
支架	GYC46320		0.757

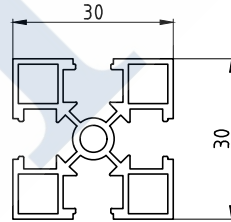

名称 Name	型号 Profile No.	壁厚 Thickness	单重(kg/m) Weight
支架	GYC-JZ094	1.0	0.635

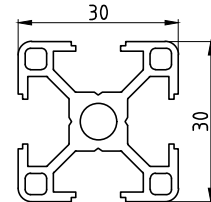

名称 Name	型号 Profile No.	壁厚 Thickness	单重(kg/m) Weight
流水线支架	GYC46361		0.762

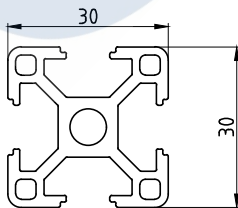

名称 Name	型号 Profile No.	壁厚 Thickness	单重(kg/m) Weight
流水线支架	GYC46362		0.863

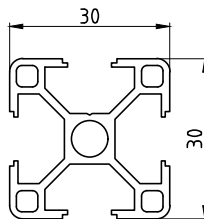

名称 Name	型号 Profile No.	壁厚 Thickness	单重(kg/m) Weight
流水线支架	GYC46364		0.67

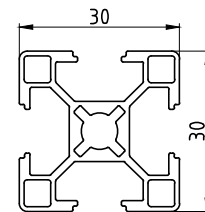

名称 Name	型号 Profile No.	壁厚 Thickness	单重(kg/m) Weight
流水线支架	GYC46365		0.646

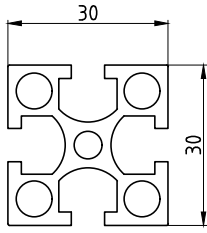

名称 Name	型号 Profile No.	壁厚 Thickness	单重(kg/m) Weight
流水线支架	GYC46371		0.951

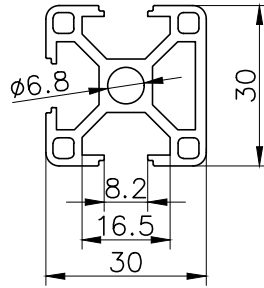

名称 Name	型号 Profile No.	壁厚 Thickness	单重(kg/m) Weight
30*30U	GYC46083		0.826

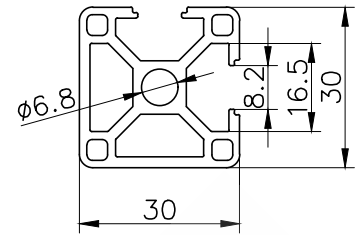

名称 Name	型号 Profile No.	壁厚 Thickness	单重(kg/m) Weight
30*30U	GYC46084		0.876

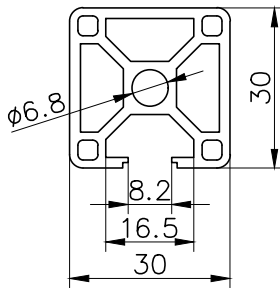

名称 Name	型号 Profile No.	壁厚 Thickness	单重(kg/m) Weight
30*30U	GYC46085		0.938

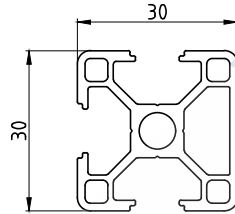

名称 Name	型号 Profile No.	壁厚 Thickness	单重(kg/m) Weight
支架料	GYC46268	1.45	0.737

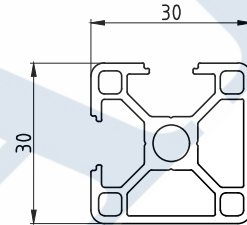

名称 Name	型号 Profile No.	壁厚 Thickness	单重(kg/m) Weight
支架料	GYC46267	1.45	0.763

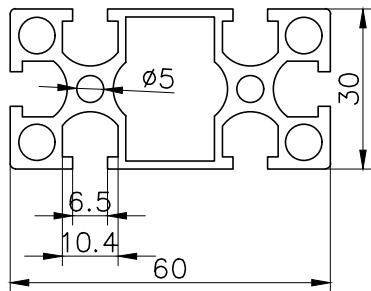

名称 Name	型号 Profile No.	壁厚 Thickness	单重(kg/m) Weight
30*60G	GYC46005		1.538

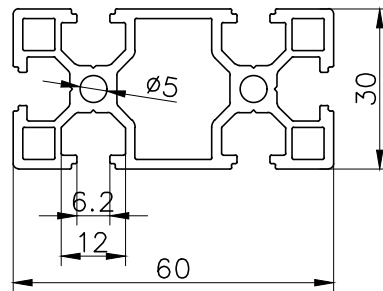

名称 Name	型号 Profile No.	壁厚 Thickness	单重(kg/m) Weight
30*60G	GYC46037	1.8	1.451

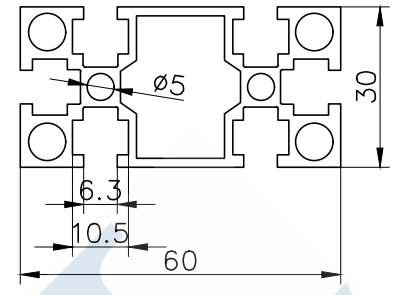

名称 Name	型号 Profile No.	壁厚 Thickness	单重(kg/m) Weight
30*60G	GYC46071		1.432

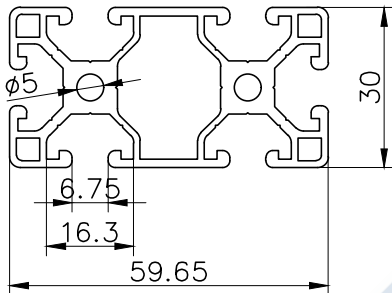

名称 Name	型号 Profile No.	壁厚 Thickness	单重(kg/m) Weight
30*59.65U	GYC46024		1.466

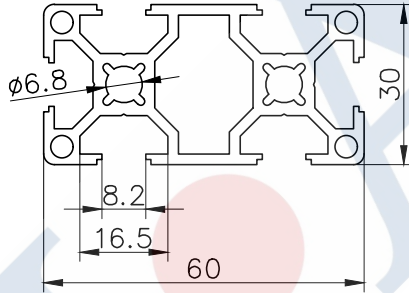

名称 Name	型号 Profile No.	壁厚 Thickness	单重(kg/m) Weight
30*60U	GYC46086		1.487

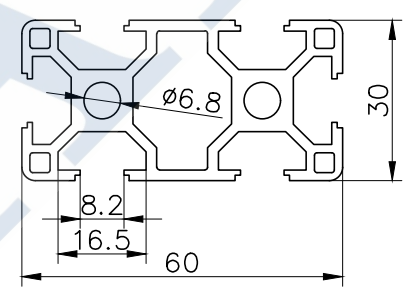

名称 Name	型号 Profile No.	壁厚 Thickness	单重(kg/m) Weight
30*60U	GYC46128	2.0	1.534

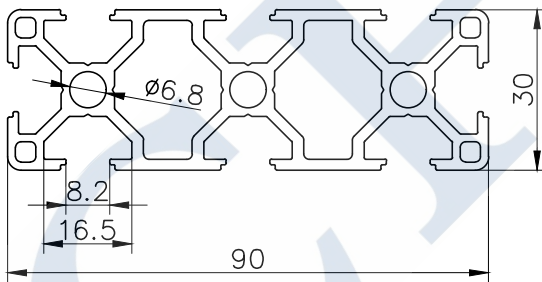

名称 Name	型号 Profile No.	壁厚 Thickness	单重(kg/m) Weight
30*90U	GYC46087	2.0	2.058

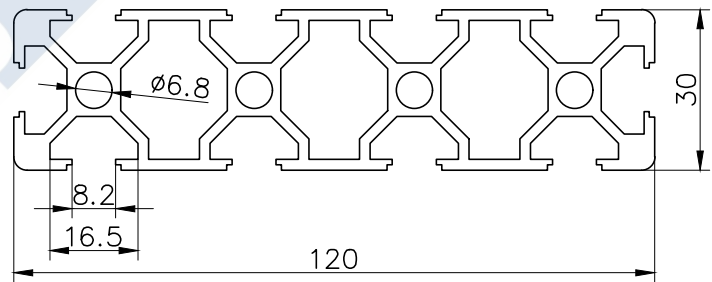

名称 Name	型号 Profile No.	壁厚 Thickness	单重(kg/m) Weight
30*120U	GYC46088	2.0	2.79

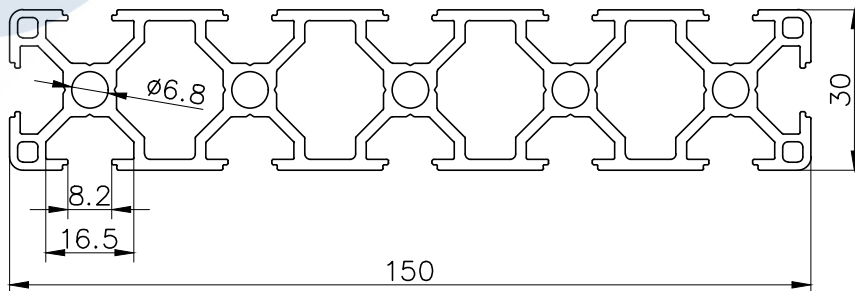

名称 Name	型号 Profile No.	壁厚 Thickness	单重(kg/m) Weight
30*150U	GYC46089		3.262

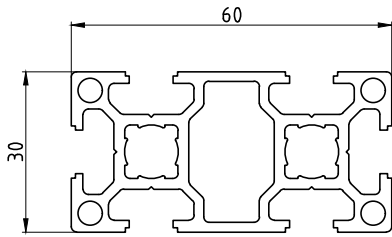

名称 Name	型号 Profile No.	壁厚 Thickness	单重(kg/m) Weight
30*60U	GYC46171		1.502

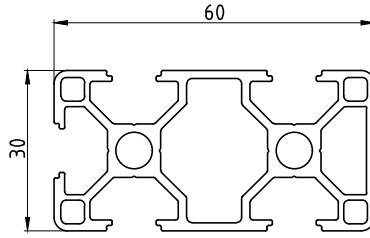

名称 Name	型号 Profile No.	壁厚 Thickness	单重(kg/m) Weight
支架料	GYC46272	1.6	0.8

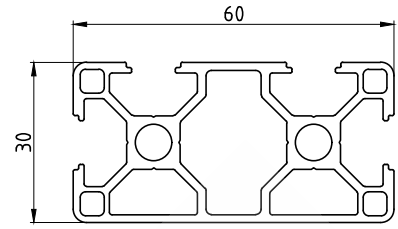

名称 Name	型号 Profile No.	壁厚 Thickness	单重(kg/m) Weight
支架料	GYC46275	1.6	1.295

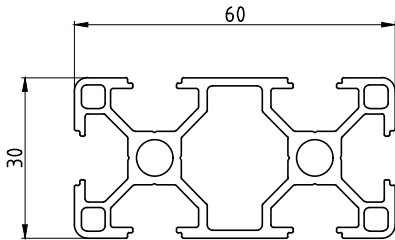

名称 Name	型号 Profile No.	壁厚 Thickness	单重(kg/m) Weight
支架料	GYC46274	1.6	1.244

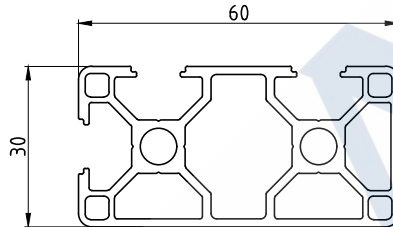

名称 Name	型号 Profile No.	壁厚 Thickness	单重(kg/m) Weight
支架料	GYC46273	1.6	1.321

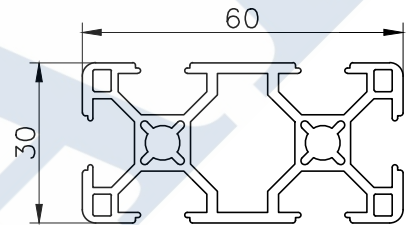

名称 Name	型号 Profile No.	壁厚 Thickness	单重(kg/m) Weight
60*30U	GYC46184		1.353

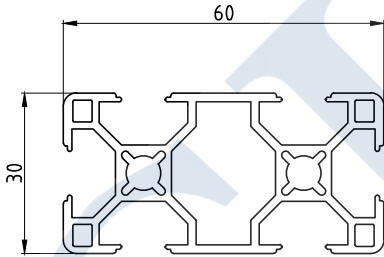

名称 Name	型号 Profile No.	壁厚 Thickness	单重(kg/m) Weight
支架	GYC46294	1.6	1.231

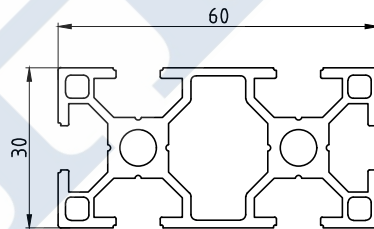

名称 Name	型号 Profile No.	壁厚 Thickness	单重(kg/m) Weight
支架	GYC46321		1.408

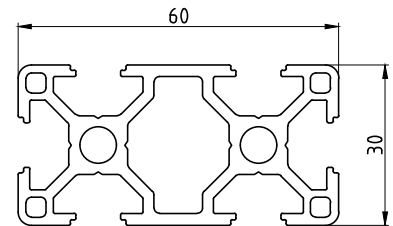

名称 Name	型号 Profile No.	壁厚 Thickness	单重(kg/m) Weight
流水线支架	GYC46337		1.531

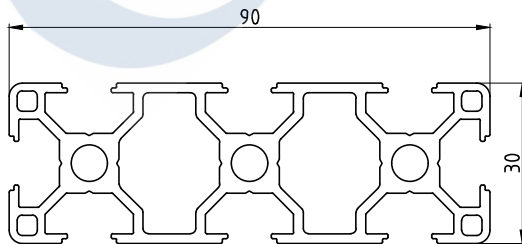

名称 Name	型号 Profile No.	壁厚 Thickness	单重(kg/m) Weight
流水线支架	GYC46338		2.06

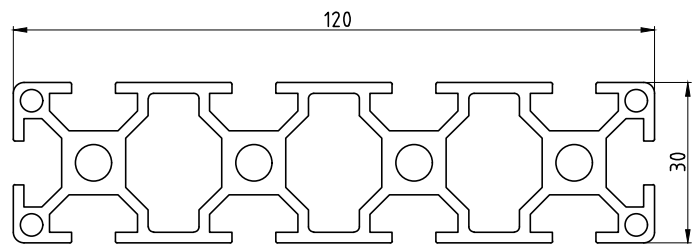

名称 Name	型号 Profile No.	壁厚 Thickness	单重(kg/m) Weight
流水线支架	GYC46398		3.063

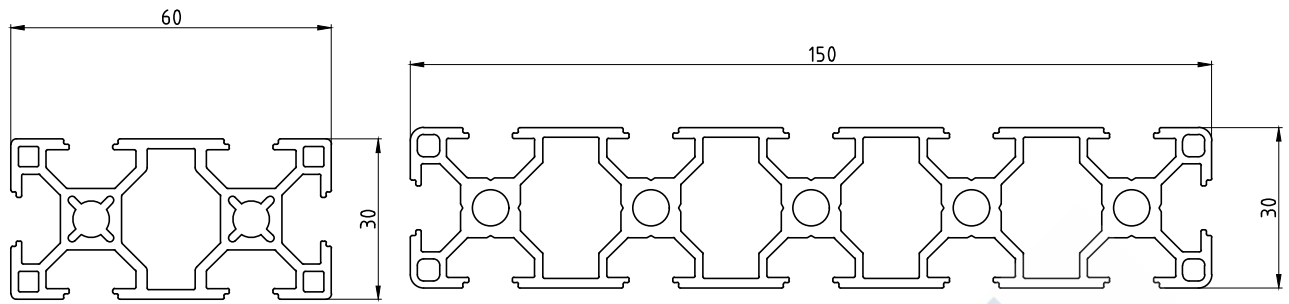

名称 Name	型号 Profile No.	壁厚 Thickness	单重(kg/m) Weight
流水线支架	GYC46393		1.424

名称 Name	型号 Profile No.	壁厚 Thickness	单重(kg/m) Weight
流水线支架	GYC46397		3.265

CH·AL

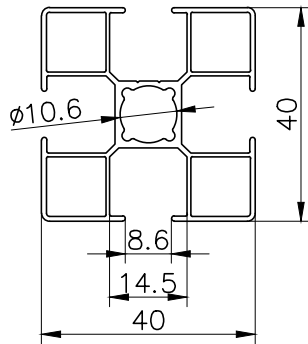

名称 Name	型号 Profile No.	壁厚 Thickness	单重(kg/m) Weight
40*40G	GYC46073		0.652

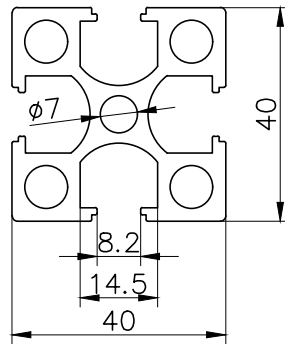

名称 Name	型号 Profile No.	壁厚 Thickness	单重(kg/m) Weight
40*40G	GYC46002	2.4	1.704

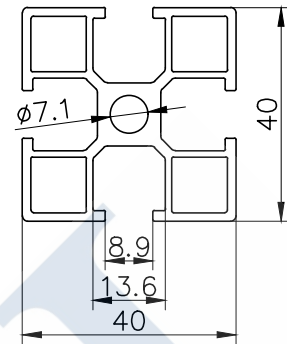

名称 Name	型号 Profile No.	壁厚 Thickness	单重(kg/m) Weight
40*40G	GYC46025		1.139

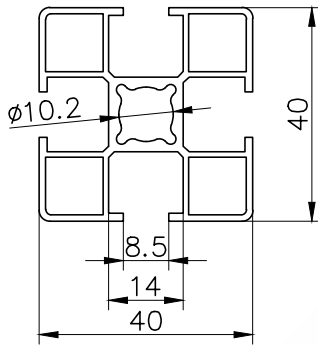

名称 Name	型号 Profile No.	壁厚 Thickness	单重(kg/m) Weight
40*40G	GYC46029		0.919

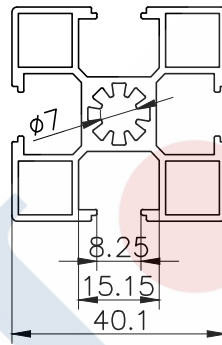

名称 Name	型号 Profile No.	壁厚 Thickness	单重(kg/m) Weight
40.1*40.1G	GYC46035		1.052

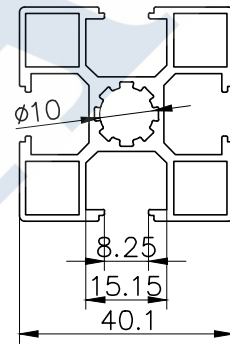

名称 Name	型号 Profile No.	壁厚 Thickness	单重(kg/m) Weight
40.1*40.1G	GYC46026		1.052

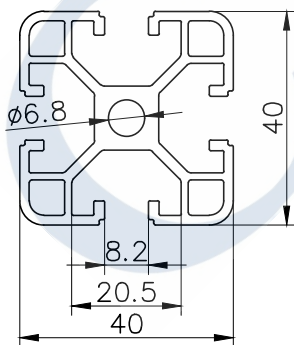

名称 Name	型号 Profile No.	壁厚 Thickness	单重(kg/m) Weight
40*40U	HJG-2028	1.8	1.298

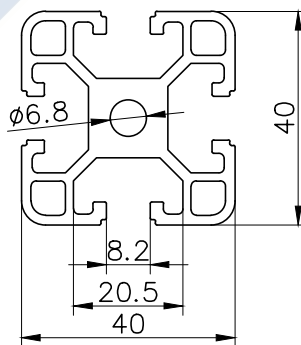

名称 Name	型号 Profile No.	壁厚 Thickness	单重(kg/m) Weight
40*40U	GYC46045		1.545

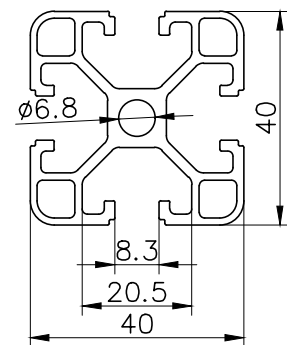

名称 Name	型号 Profile No.	壁厚 Thickness	单重(kg/m) Weight
40*40U	GYC46062		1.229

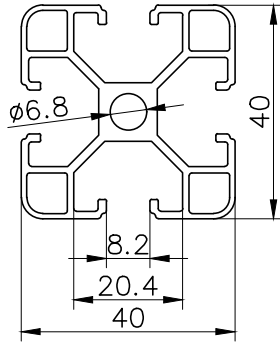

名称 Name	型号 Profile No.	壁厚 Thickness	单重(kg/m) Weight
40*40U	GYC46064		0.994

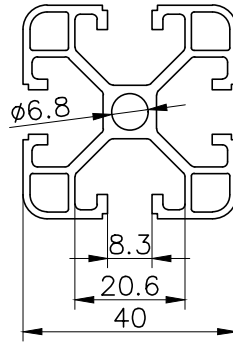

名称 Name	型号 Profile No.	壁厚 Thickness	单重(kg/m) Weight
40*40U	GYC46075		1.134

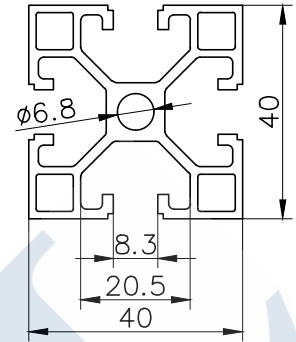

名称 Name	型号 Profile No.	壁厚 Thickness	单重(kg/m) Weight
40*40U	GYC46069		1.244

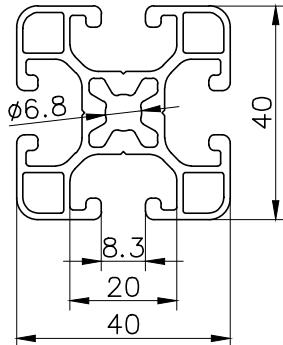

名称 Name	型号 Profile No.	壁厚 Thickness	单重(kg/m) Weight
40*40U	GYC46033		1.287

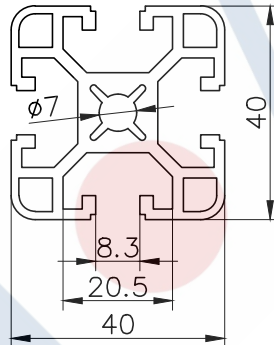

名称 Name	型号 Profile No.	壁厚 Thickness	单重(kg/m) Weight
40*40U	GYC46061		1.545

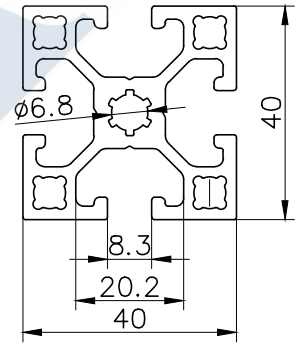

名称 Name	型号 Profile No.	壁厚 Thickness	单重(kg/m) Weight
40*40U	EX-KOR-049		1.602

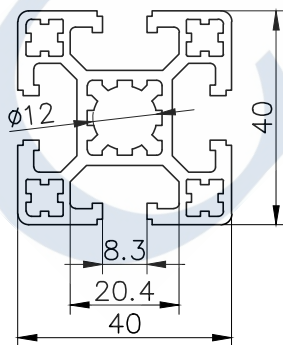

名称 Name	型号 Profile No.	壁厚 Thickness	单重(kg/m) Weight
40*40U	GYC108001		1.503

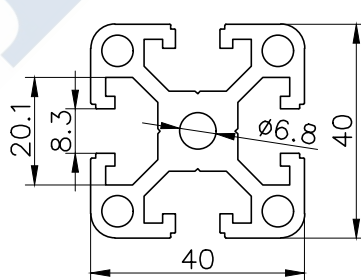

名称 Name	型号 Profile No.	壁厚 Thickness	单重(kg/m) Weight
40*40U	GYC46131	2.8	1.826

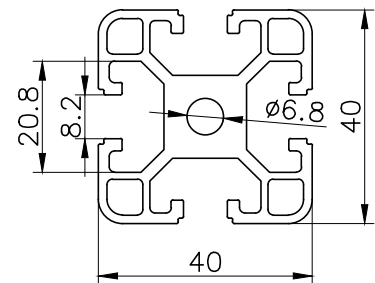

名称 Name	型号 Profile No.	壁厚 Thickness	单重(kg/m) Weight
40*40U	GYC46129	1.3	1.54

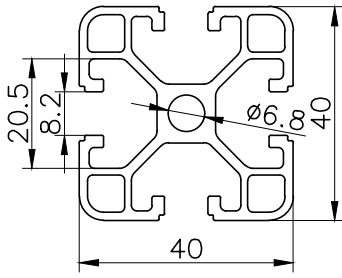

名称 Name	型号 Profile No.	壁厚 Thickness	单重(kg/m) Weight
40*40U	GYC46130	1.25	1.232

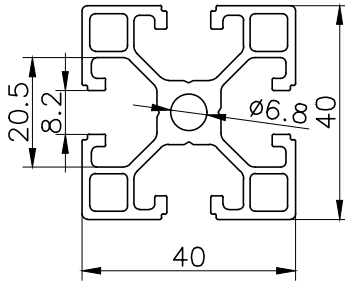

名称 Name	型号 Profile No.	壁厚 Thickness	单重(kg/m) Weight
40*40U	GYC46132	1.8	1.289

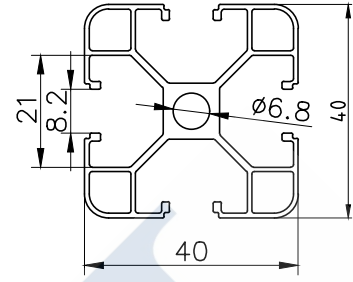

名称 Name	型号 Profile No.	壁厚 Thickness	单重(kg/m) Weight
40*40U	GYC46143	0.9	0.79

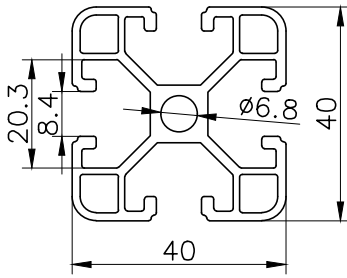

名称 Name	型号 Profile No.	壁厚 Thickness	单重(kg/m) Weight
40*40U	GYC46144	1.5	1.193

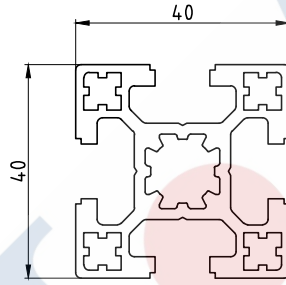

名称 Name	型号 Profile No.	壁厚 Thickness	单重(kg/m) Weight
40*40U	GYC46156		1.562

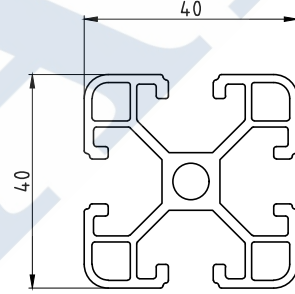

名称 Name	型号 Profile No.	壁厚 Thickness	单重(kg/m) Weight
40*40U	GYC46228		1.193

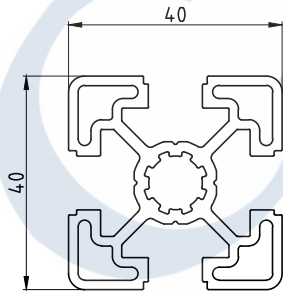

名称 Name	型号 Profile No.	壁厚 Thickness	单重(kg/m) Weight
40*40U	GYC46232	1.8	1.421

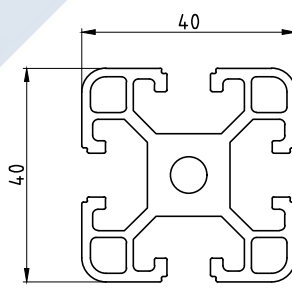

名称 Name	型号 Profile No.	壁厚 Thickness	单重(kg/m) Weight
40*40U	GYC46234	1.6	1.546

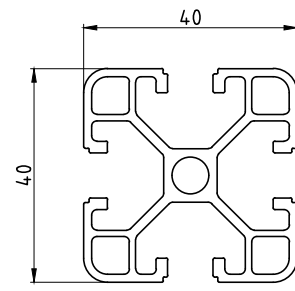

名称 Name	型号 Profile No.	壁厚 Thickness	单重(kg/m) Weight
40*40U	GYC46236	1.5	1.130

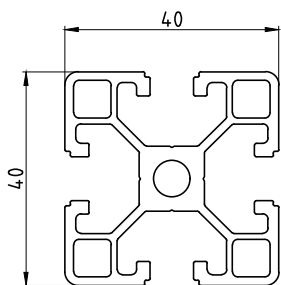

名称 Name	型号 Profile No.	壁厚 Thickness	单重(kg/m) Weight
支架料	GYC46269	1.6	1.295

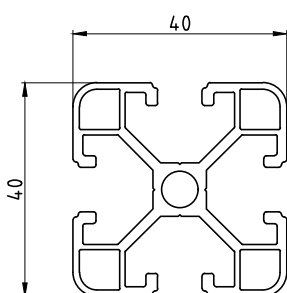

名称 Name	型号 Profile No.	壁厚 Thickness	单重(kg/m) Weight
40*40T支架料	GYC46317	2.0	1.074

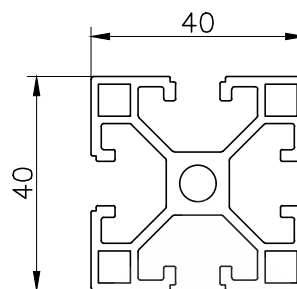

名称 Name	型号 Profile No.	壁厚 Thickness	单重(kg/m) Weight
40*40U	GYC46182		1.295

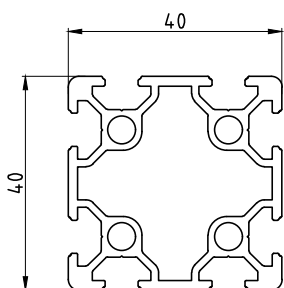

名称 Name	型号 Profile No.	壁厚 Thickness	单重(kg/m) Weight
40*40BD型材	GYC46312	1.8	1.148

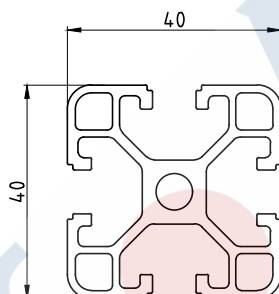

名称 Name	型号 Profile No.	壁厚 Thickness	单重(kg/m) Weight
40*40C型材截面	GYC46311		1.313

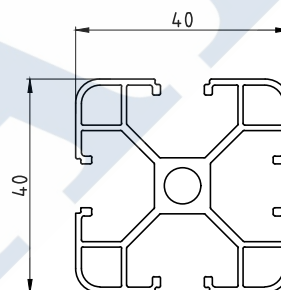

名称 Name	型号 Profile No.	壁厚 Thickness	单重(kg/m) Weight
40*40H型材截面	GYC46310		0.893

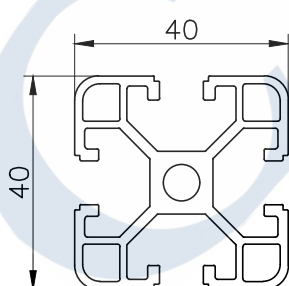

名称 Name	型号 Profile No.	壁厚 Thickness	单重(kg/m) Weight
40*40U	GYC46183		1.276

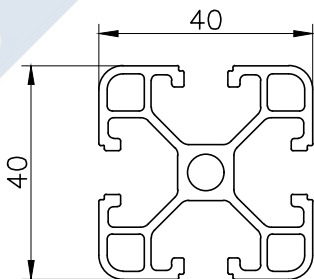

名称 Name	型号 Profile No.	壁厚 Thickness	单重(kg/m) Weight
40*40U	GYC46191		1.152

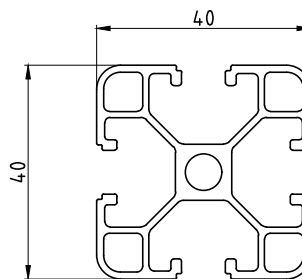

名称 Name	型号 Profile No.	壁厚 Thickness	单重(kg/m) Weight
支架	GYC46279	1.4	1.029

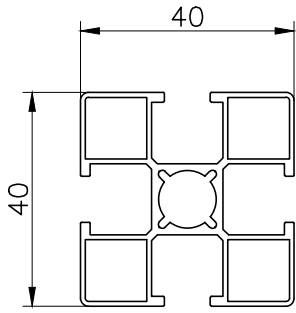

名称 Name	型号 Profile No.	壁厚 Thickness	单重(kg/m) Weight
40*40U	GYC46192		0.789

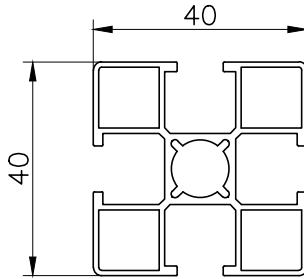

名称 Name	型号 Profile No.	壁厚 Thickness	单重(kg/m) Weight
40*40U	GYC46193		0.838

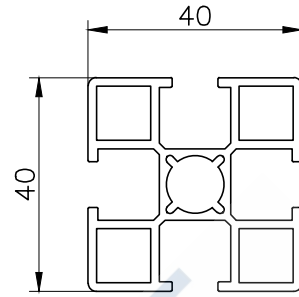

名称 Name	型号 Profile No.	壁厚 Thickness	单重(kg/m) Weight
40*40U	GYC46194		1.117

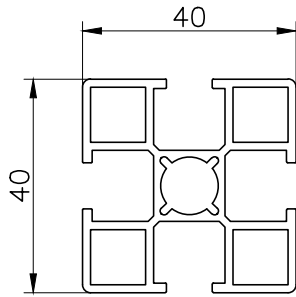

名称 Name	型号 Profile No.	壁厚 Thickness	单重(kg/m) Weight
40*40U	GYC46195		1.072

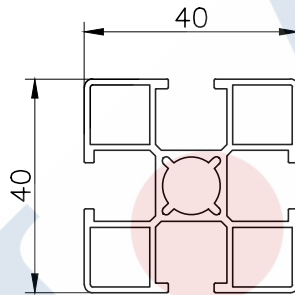

名称 Name	型号 Profile No.	壁厚 Thickness	单重(kg/m) Weight
40*40U	GYC46196		0.887

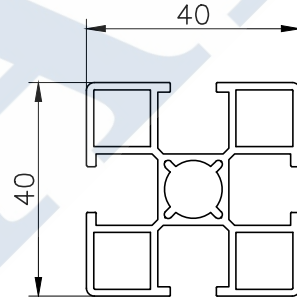

名称 Name	型号 Profile No.	壁厚 Thickness	单重(kg/m) Weight
40*40U	GYC46197		1.004

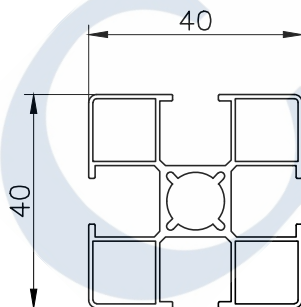

名称 Name	型号 Profile No.	壁厚 Thickness	单重(kg/m) Weight
40*40U	GYC46198		0.708

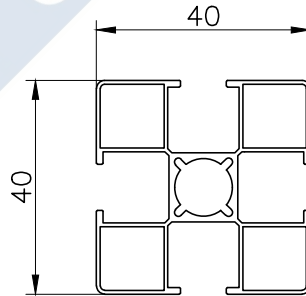

名称 Name	型号 Profile No.	壁厚 Thickness	单重(kg/m) Weight
40*40U	GYC46199		0.622

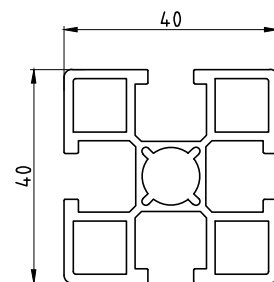

名称 Name	型号 Profile No.	壁厚 Thickness	单重(kg/m) Weight
支料	GYC46209		1.184

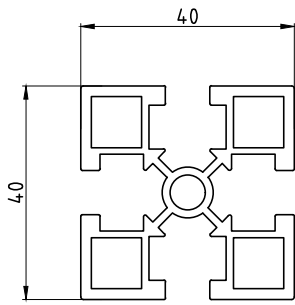

名称 Name	型号 Profile No.	壁厚 Thickness	单重(kg/m) Weight
支架	GYC-JZ007		1.283

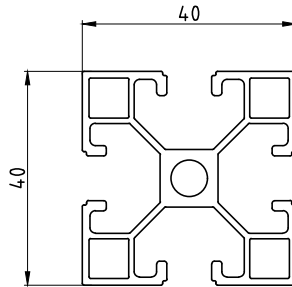

名称 Name	型号 Profile No.	壁厚 Thickness	单重(kg/m) Weight
支架	GYC46323		1.052

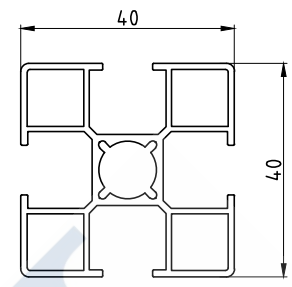

名称 Name	型号 Profile No.	壁厚 Thickness	单重(kg/m) Weight
支架	GYC46322	1.9	0.846

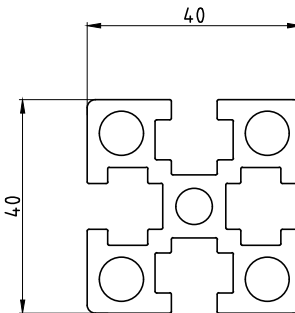

名称 Name	型号 Profile No.	壁厚 Thickness	单重(kg/m) Weight
支架	GYC-JZ106		1.844

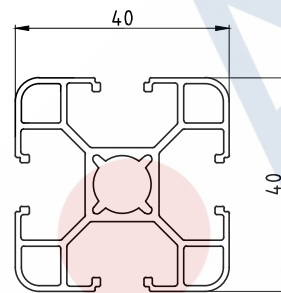

名称 Name	型号 Profile No.	壁厚 Thickness	单重(kg/m) Weight
支架	GYC-JZ116	1.1	0.876

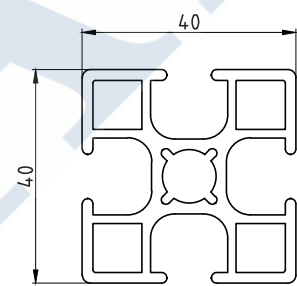

名称 Name	型号 Profile No.	壁厚 Thickness	单重(kg/m) Weight
支架	GYC46299	2.0	1.355

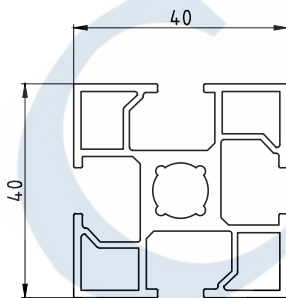

名称 Name	型号 Profile No.	壁厚 Thickness	单重(kg/m) Weight
支架	GYC46287	1.4	1.152

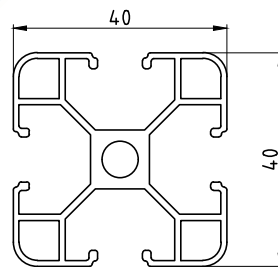

名称 Name	型号 Profile No.	壁厚 Thickness	单重(kg/m) Weight
流水线支架	GYC46339		0.916

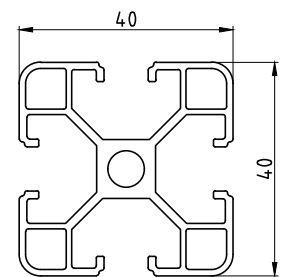

名称 Name	型号 Profile No.	壁厚 Thickness	单重(kg/m) Weight
流水线支架	GYC46340		0.992

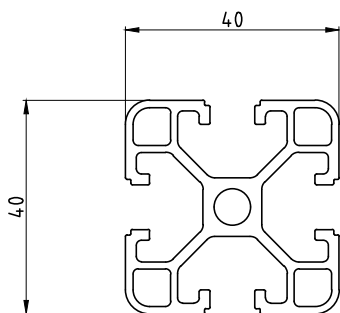

名称 Name	型号 Profile No.	壁厚 Thickness	单重(kg/m) Weight
流水线支架	GYC46341		1.227

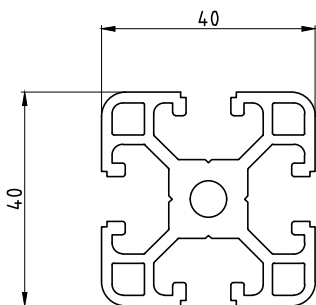

名称 Name	型号 Profile No.	壁厚 Thickness	单重(kg/m) Weight
流水线支架	GYC46343		1.621

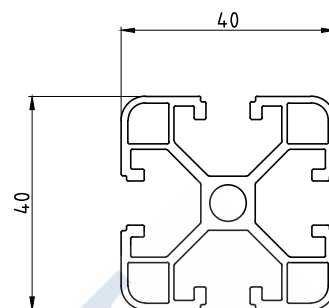

名称 Name	型号 Profile No.	壁厚 Thickness	单重(kg/m) Weight
流水线支架	GYC46342		1.087

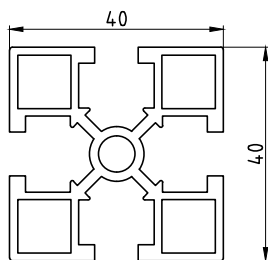

名称 Name	型号 Profile No.	壁厚 Thickness	单重(kg/m) Weight
流水线支架	GYC46354	1.5	1.19

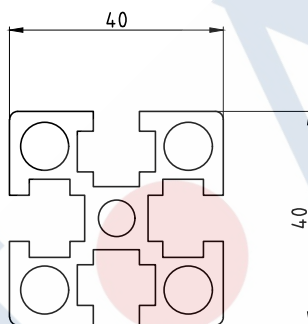

名称 Name	型号 Profile No.	壁厚 Thickness	单重(kg/m) Weight
流水线支架	GYC46396		1.734

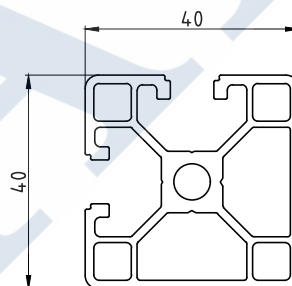

名称 Name	型号 Profile No.	壁厚 Thickness	单重(kg/m) Weight
支架料	GYC46271	1.6	1.233

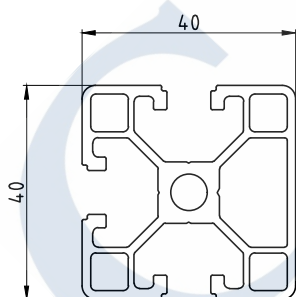

名称 Name	型号 Profile No.	壁厚 Thickness	单重(kg/m) Weight
支架料	GYC46270	1.6	1.250

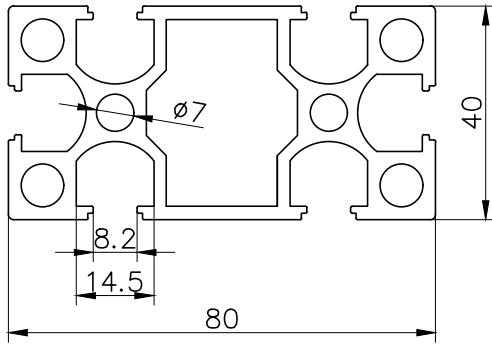

名称	型号	壁厚	单重(kg/m)
Name	Profile No.	Thickness	Weight
40*80G	GYC46003	2.4	2.743

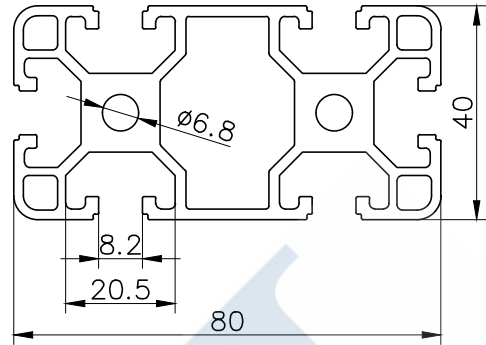

名称	型号	壁厚	单重(kg/m)
Name	Profile No.	Thickness	Weight
40*80U	GYC46046		2.716

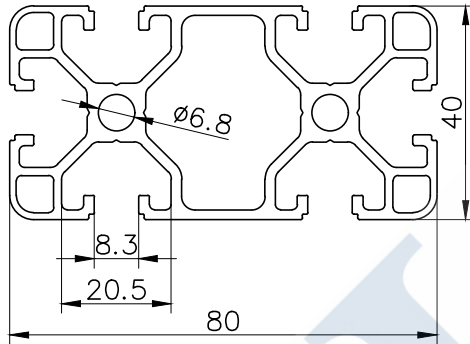

名称	型号	壁厚	单重(kg/m)
Name	Profile No.	Thickness	Weight
40*80U	GYC46067		2.145

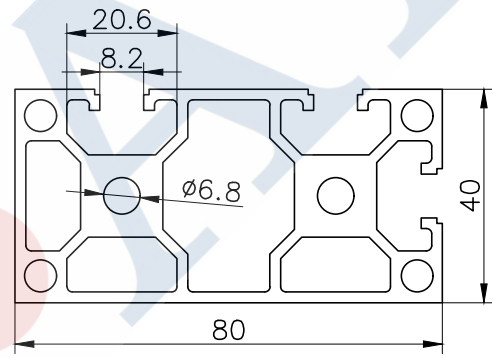

名称	型号	壁厚	单重(kg/m)
Name	Profile No.	Thickness	Weight
40*80U	GYC46134	2.0	2.967

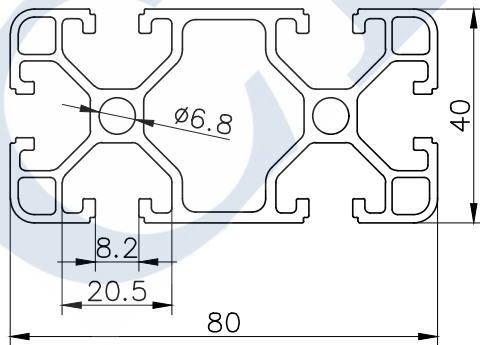

名称	型号	壁厚	单重(kg/m)
Name	Profile No.	Thickness	Weight
40*80U	GYC46074		2.112

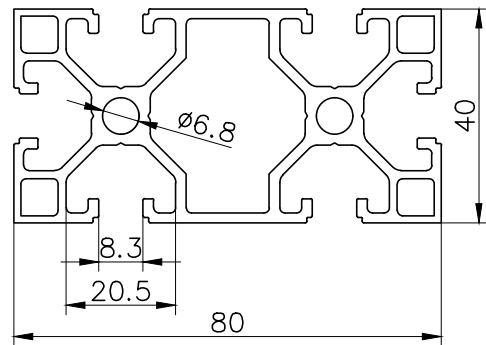

名称	型号	壁厚	单重(kg/m)
Name	Profile No.	Thickness	Weight
40*80U	GYC46068		2.171

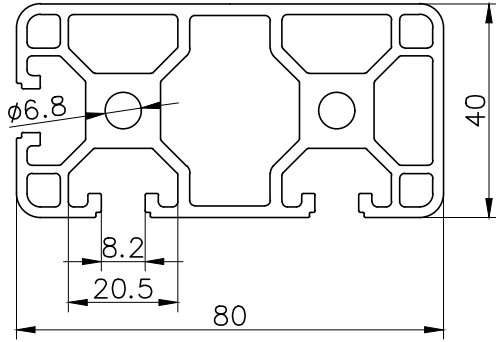

名称 Name	型号 Profile No.	壁厚 Thickness	单重(kg/m) Weight
40*80U	GYC46090		2.759

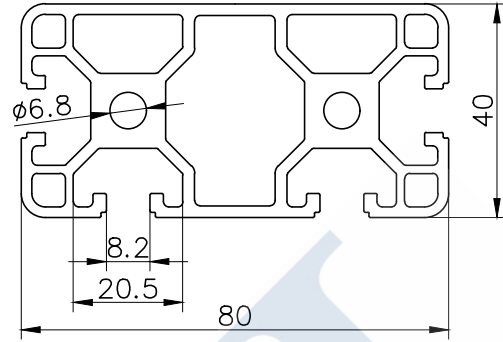

名称 Name	型号 Profile No.	壁厚 Thickness	单重(kg/m) Weight
40*80U	GYC46091		2.744

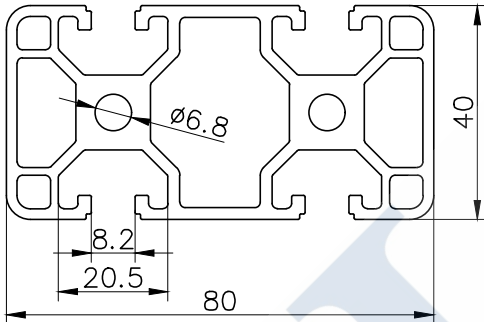

名称 Name	型号 Profile No.	壁厚 Thickness	单重(kg/m) Weight
40*80U	GYC46092		2.744

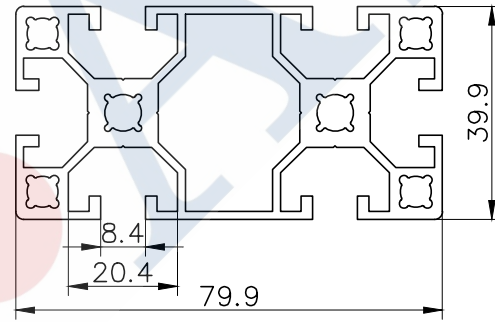

名称 Name	型号 Profile No.	壁厚 Thickness	单重(kg/m) Weight
39.9*79.9U	GYC46027		2.36

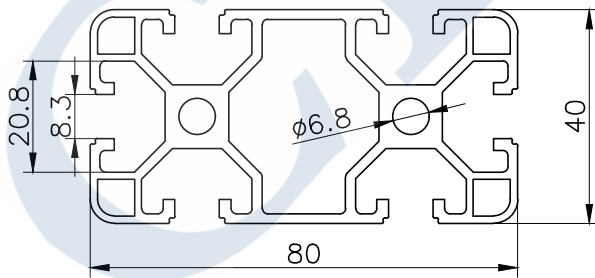

名称 Name	型号 Profile No.	壁厚 Thickness	单重(kg/m) Weight
40*80U	GYC46133	1.8	2.206

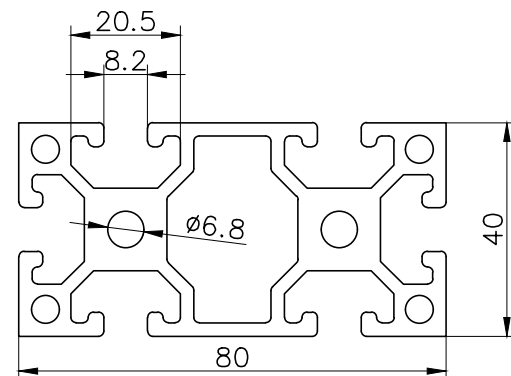

名称 Name	型号 Profile No.	壁厚 Thickness	单重(kg/m) Weight
40*80U	GYC46135	2.5	3.298

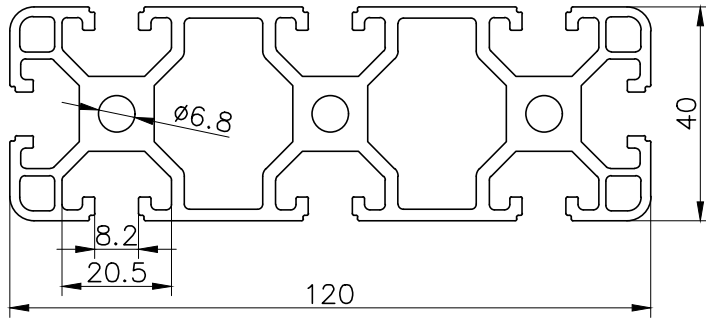

名称	型号	壁厚	单重(kg/m)
Name	Profile No.	Thickness	Weight
40*120U	GYC46093		3.9

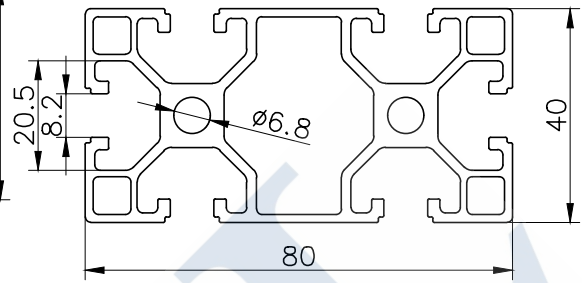

名称	型号	壁厚	单重(kg/m)
Name	Profile No.	Thickness	Weight
40*80U	GYC46136	1.8	2.221

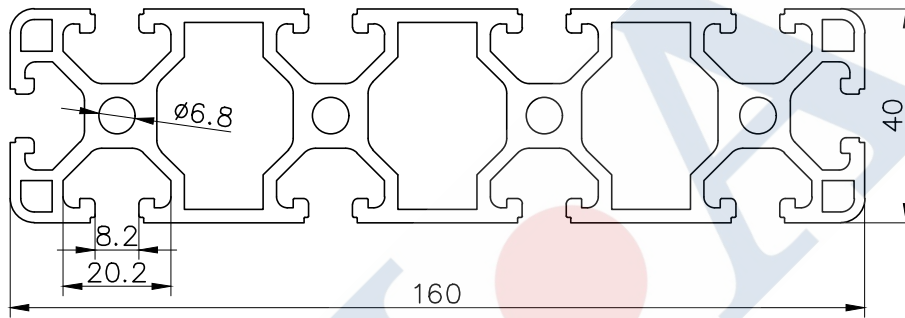

名称	型号	壁厚	单重(kg/m)
Name	Profile No.	Thickness	Weight
40*160U	GYC46094		5.385

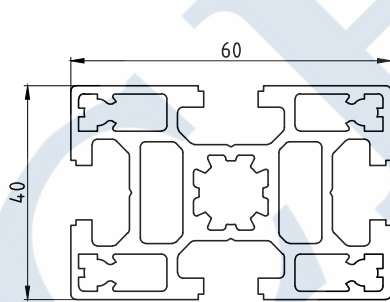

名称	型号	壁厚	单重(kg/m)
Name	Profile No.	Thickness	Weight
40*60U	GYC46157	2.0	2.256

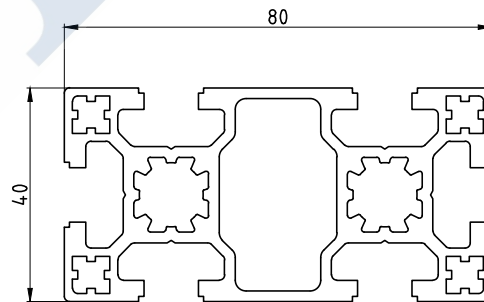

名称	型号	壁厚	单重(kg/m)
Name	Profile No.	Thickness	Weight
40*80U	GYC46158		2.676

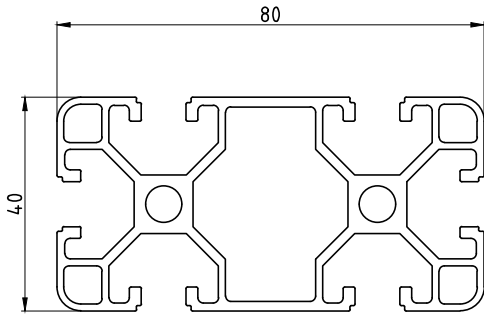

名称	型号	壁厚	单重(kg/m)
Name	Profile No.	Thickness	Weight
支架料	GYC46235	1.3	2.013

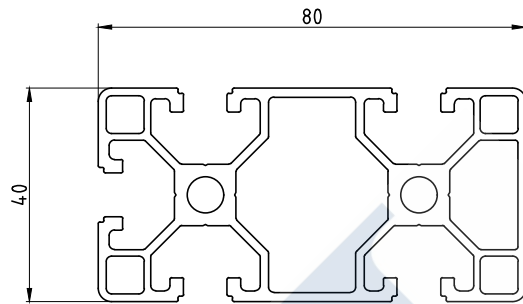

名称	型号	壁厚	单重(kg/m)
Name	Profile No.	Thickness	Weight
支架料	GYC46276	1.6	2.132

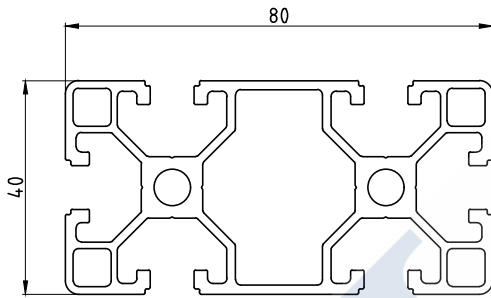

名称	型号	壁厚	单重(kg/m)
Name	Profile No.	Thickness	Weight
支架料	GYC46278	1.6	2.148

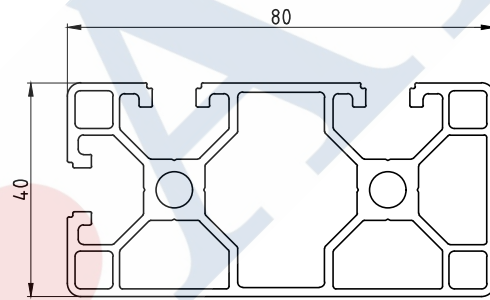

名称	型号	壁厚	单重(kg/m)
Name	Profile No.	Thickness	Weight
支架料	GYC46277	1.6	2.100

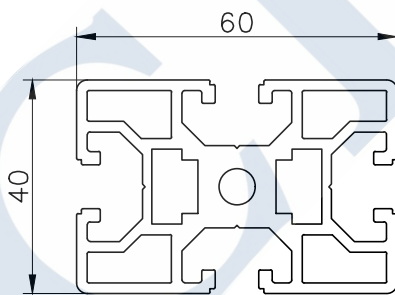

名称	型号	壁厚	单重(kg/m)
Name	Profile No.	Thickness	Weight
60*40U	GYC46176	2.0	2.412

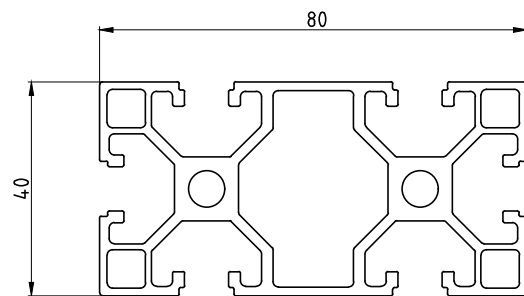

名称	型号	壁厚	单重(kg/m)
Name	Profile No.	Thickness	Weight
80*40U	GYC46180		2.214

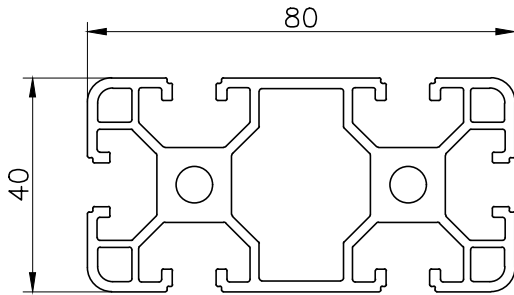

名称 Name	型号 Profile No.	壁厚 Thickness	单重(kg/m) Weight
80*40U	GYC46189		2.458

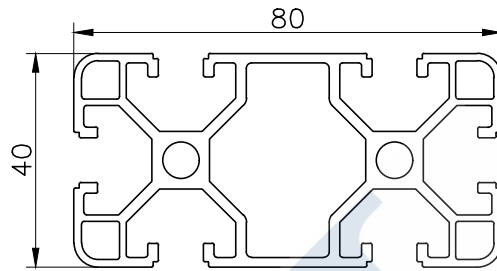

名称 Name	型号 Profile No.	壁厚 Thickness	单重(kg/m) Weight
80*40U	GYC46190		2.083

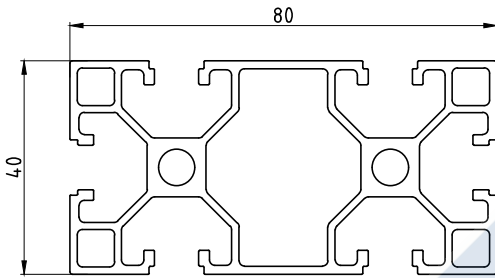

名称 Name	型号 Profile No.	壁厚 Thickness	单重(kg/m) Weight
40*80U	GYC46222	1.4	1.955

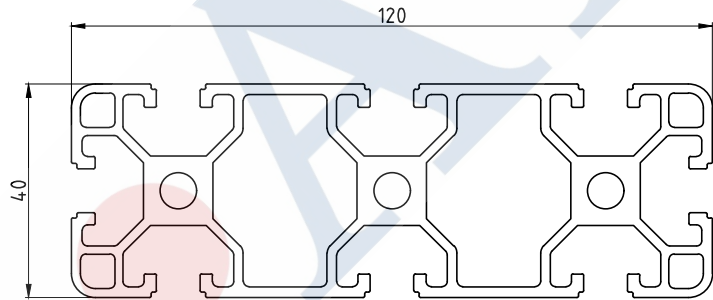

名称 Name	型号 Profile No.	壁厚 Thickness	单重(kg/m) Weight
40*120U	GYC46213	1.8	3.46

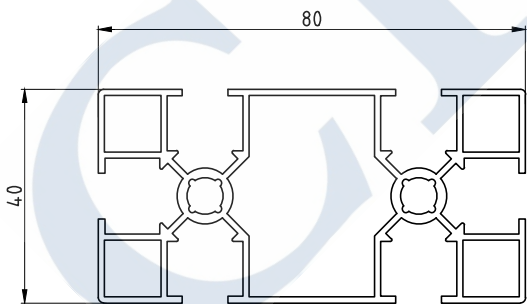

名称 Name	型号 Profile No.	壁厚 Thickness	单重(kg/m) Weight
支架	GYC46245	1.15	1.453

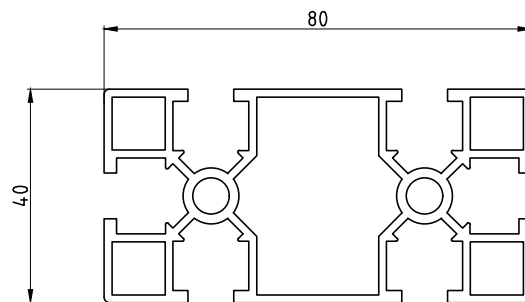

名称 Name	型号 Profile No.	壁厚 Thickness	单重(kg/m) Weight
支架	GYC46246	1.5	1.843

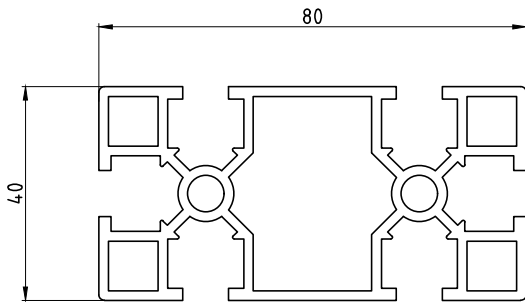

名称	型号	壁厚	单重(kg/m)
Name	Profile No.	Thickness	Weight
支架	GYC46247	1.8	2.069

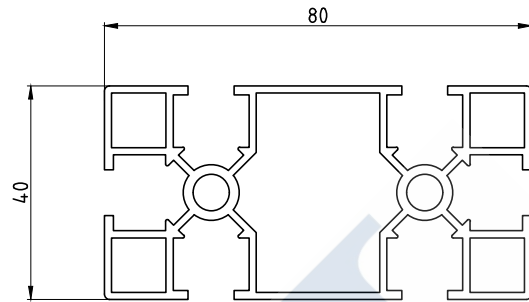

名称	型号	壁厚	单重(kg/m)
Name	Profile No.	Thickness	Weight
支架	GYC46248	1.35	1.671

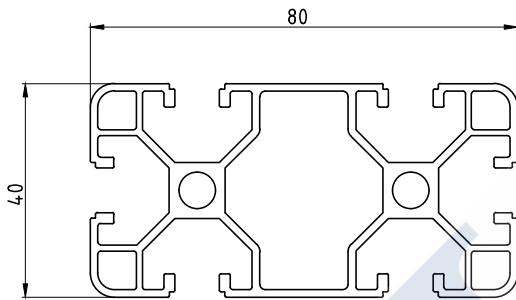

名称	型号	壁厚	单重(kg/m)
Name	Profile No.	Thickness	Weight
支架	GYC46261	1.4	1.816

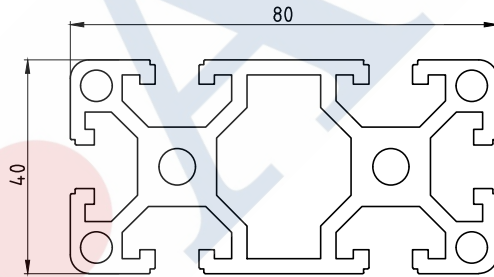

名称	型号	壁厚	单重(kg/m)
Name	Profile No.	Thickness	Weight
支架	GYC46260	2.8	3.247

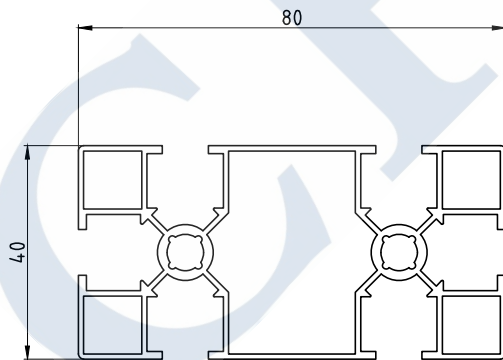

名称	型号	壁厚	单重(kg/m)
Name	Profile No.	Thickness	Weight
支架	GYC-JZ115	1.0	1.336

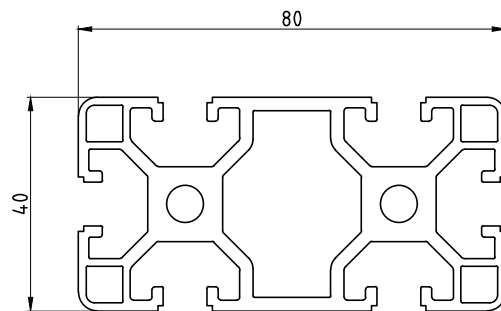

名称	型号	壁厚	单重(kg/m)
Name	Profile No.	Thickness	Weight
流水线支架	GYC46348		2.671

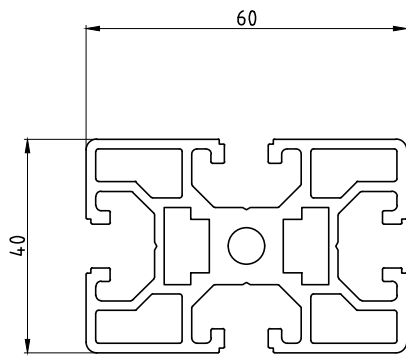

名称 Name	型号 Profile No.	壁厚 Thickness	单重(kg/m) Weight
流水线支架	GYC46344		2.23

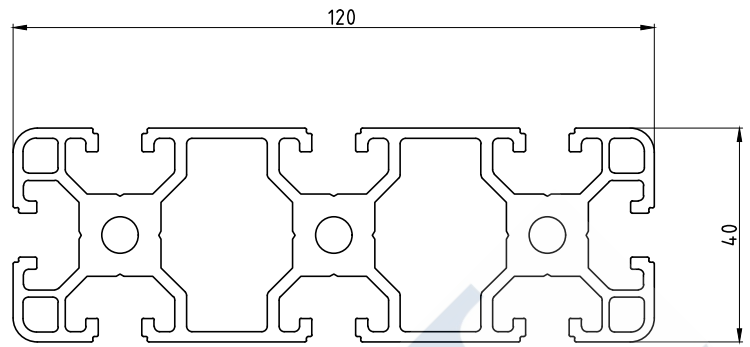

名称 Name	型号 Profile No.	壁厚 Thickness	单重(kg/m) Weight
流水线支架	GYC46358	2.2	4.02

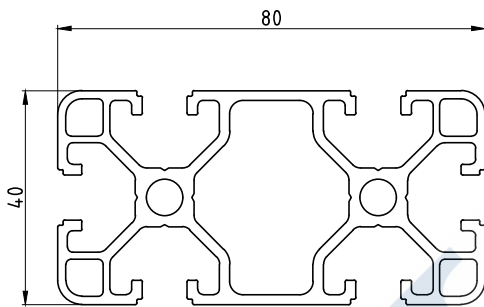

名称 Name	型号 Profile No.	壁厚 Thickness	单重(kg/m) Weight
流水线支架	GYC46346		2.14

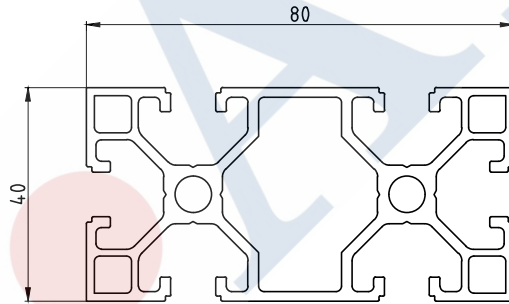

名称 Name	型号 Profile No.	壁厚 Thickness	单重(kg/m) Weight
流水线支架	GYC46347		2.169

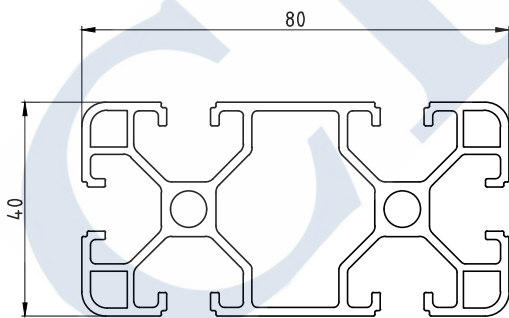

名称 Name	型号 Profile No.	壁厚 Thickness	单重(kg/m) Weight
流水线支架	GYC46345		1.899

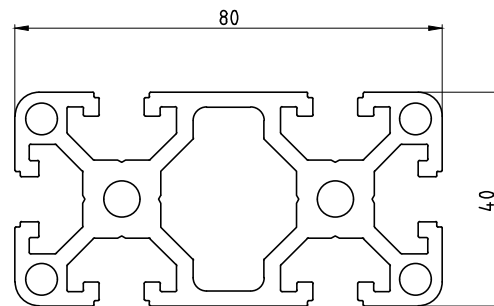

名称 Name	型号 Profile No.	壁厚 Thickness	单重(kg/m) Weight
流水线支架	GYC46357	2.95	3.21

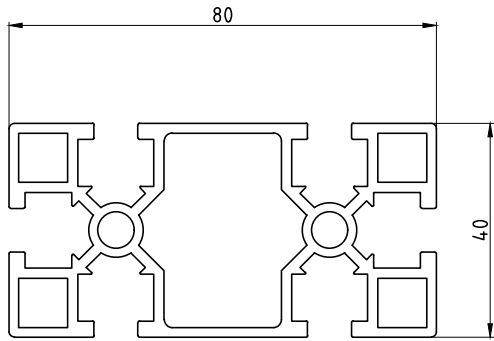

名称 Name	型号 Profile No.	壁厚 Thickness	单重(kg/m) Weight
流水线支架	GYC46395		2.231

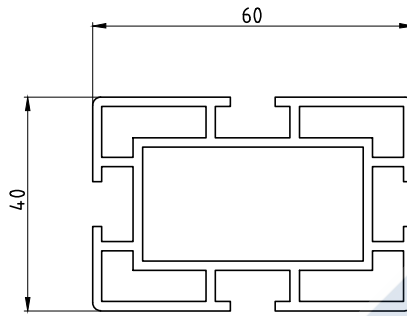

名称 Name	型号 Profile No.	壁厚 Thickness	单重(kg/m) Weight
支架	GYC46242	1.75	1.6

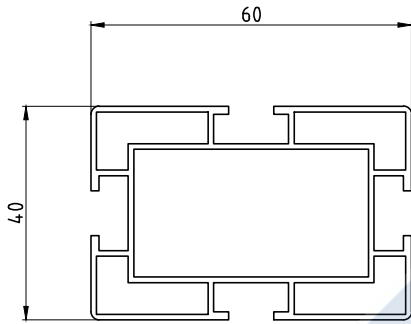

名称 Name	型号 Profile No.	壁厚 Thickness	单重(kg/m) Weight
支架	GYC46243	1.05	1.017

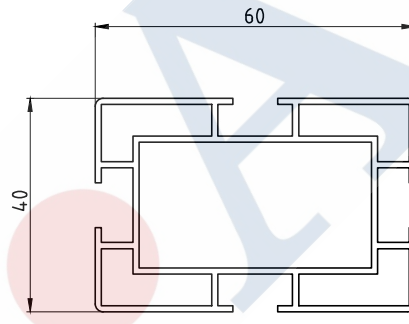

名称 Name	型号 Profile No.	壁厚 Thickness	单重(kg/m) Weight
支架	GYC46240	1.15	1.079

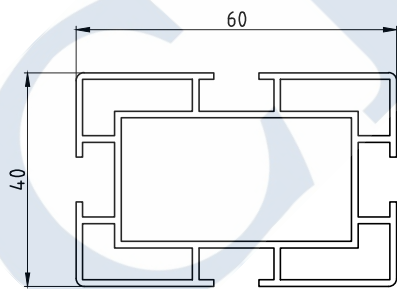

名称 Name	型号 Profile No.	壁厚 Thickness	单重(kg/m) Weight
支架	GYC46239	1.25	1.168

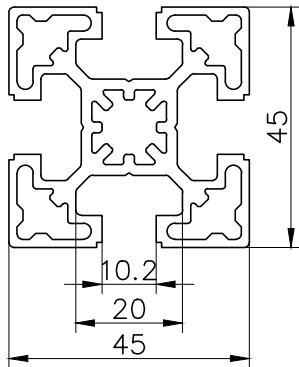

名称 Name	型号 Profile No.	壁厚 Thickness	单重(kg/m) Weight
45*45U	GYC83001	2.0	1.802

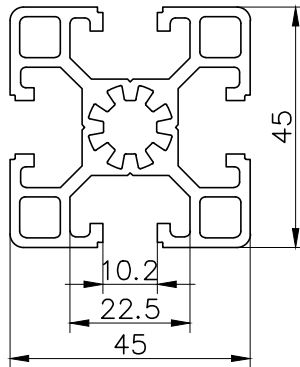

名称 Name	型号 Profile No.	壁厚 Thickness	单重(kg/m) Weight
45*45U	HJG-1664	1.8	1.733

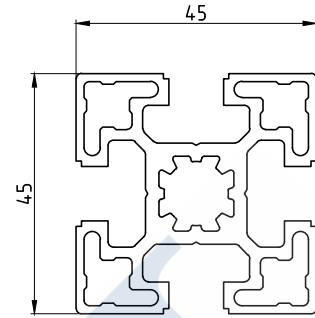

名称 Name	型号 Profile No.	壁厚 Thickness	单重(kg/m) Weight
45*45U	GYC46166	2.0	1.808

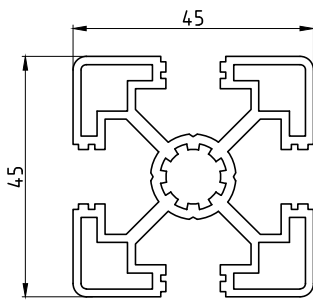

名称 Name	型号 Profile No.	壁厚 Thickness	单重(kg/m) Weight
4545L型材	GYC46313	1.5	1.518

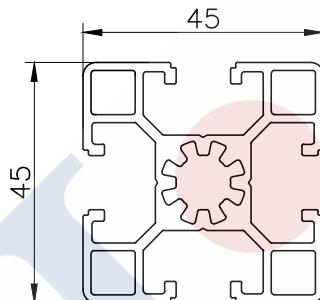

名称 Name	型号 Profile No.	壁厚 Thickness	单重(kg/m) Weight
45*45U	GYC46175	1.5	1.507

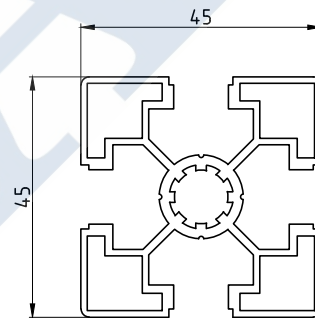

名称 Name	型号 Profile No.	壁厚 Thickness	单重(kg/m) Weight
支架	GYC46259	1.2	1.275

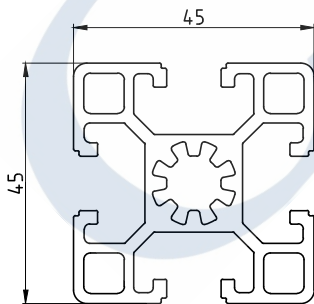

名称 Name	型号 Profile No.	壁厚 Thickness	单重(kg/m) Weight
支架	GYC46301	1.9	1.776

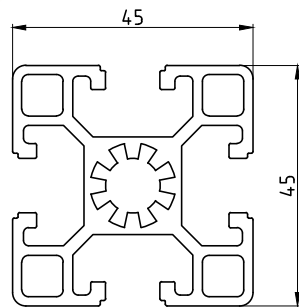

名称 Name	型号 Profile No.	壁厚 Thickness	单重(kg/m) Weight
流水线支架	GYC46378		1.757

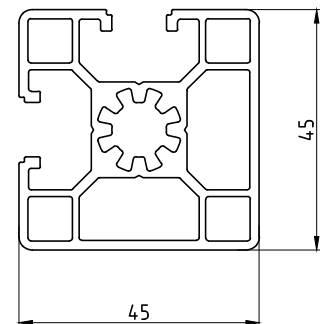

名称 Name	型号 Profile No.	壁厚 Thickness	单重(kg/m) Weight
支架	GYC-JZ108	1.5	1.562

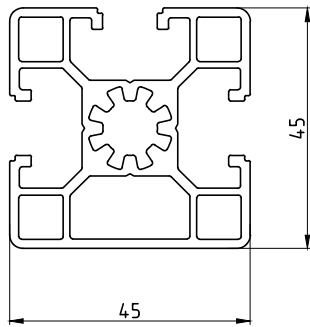

名称	型号	壁厚	单重(kg/m)
Name	Profile No.	Thickness	Weight
支架	GYC-JZ107	1.5	1.531

CH·AL

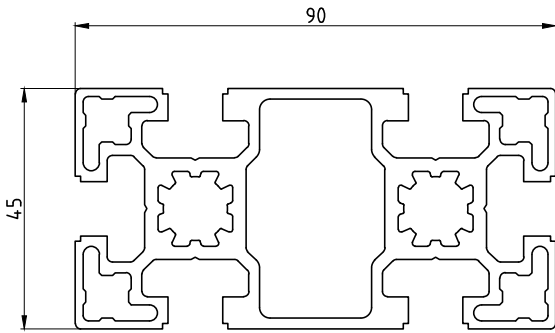

名称 Name	型号 Profile No.	壁厚 Thickness	单重(kg/m) Weight
45*90U	GYC46167	2.0	3.24

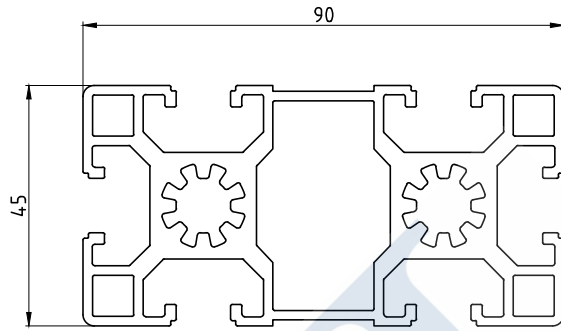

名称 Name	型号 Profile No.	壁厚 Thickness	单重(kg/m) Weight
90*45U	GYC46231	1.8	3.274

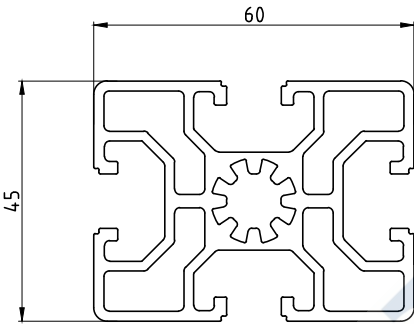

名称 Name	型号 Profile No.	壁厚 Thickness	单重(kg/m) Weight
45*60U	GYC46208		2.252

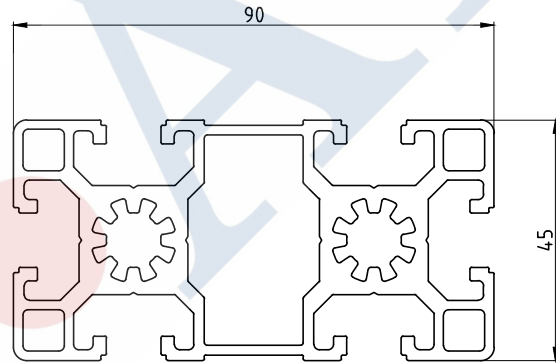

名称 Name	型号 Profile No.	壁厚 Thickness	单重(kg/m) Weight
流水线支架	GYC46379		3.451

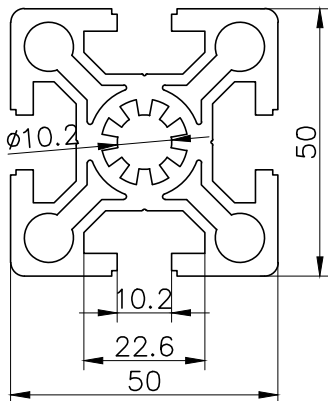

名称 Name	型号 Profile No.	壁厚 Thickness	单重(kg/m) Weight
50*50U	GYC46096		2.816

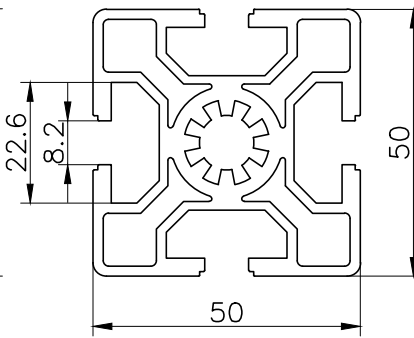

名称 Name	型号 Profile No.	壁厚 Thickness	单重(kg/m) Weight
50*50U	GYC46137	1.9	2.410

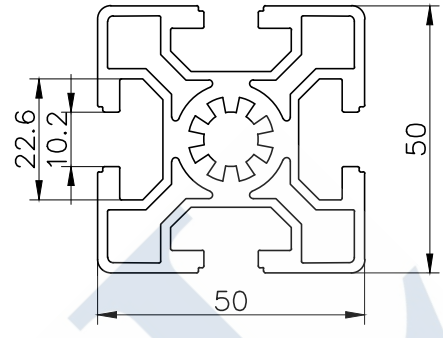

名称 Name	型号 Profile No.	壁厚 Thickness	单重(kg/m) Weight
50*50U	GYC46138	1.9	2.462

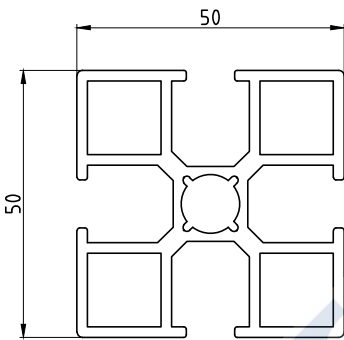

名称 Name	型号 Profile No.	壁厚 Thickness	单重(kg/m) Weight
支架	GYC46302	2.0	1.82

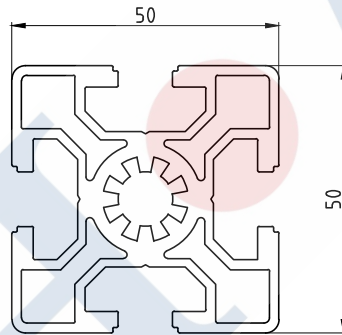

名称 Name	型号 Profile No.	壁厚 Thickness	单重(kg/m) Weight
流水线支架	GYC46355	1.8	2.46

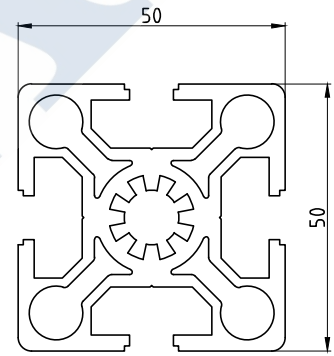

名称 Name	型号 Profile No.	壁厚 Thickness	单重(kg/m) Weight
流水线支架	GYC46356	1.8	2.634

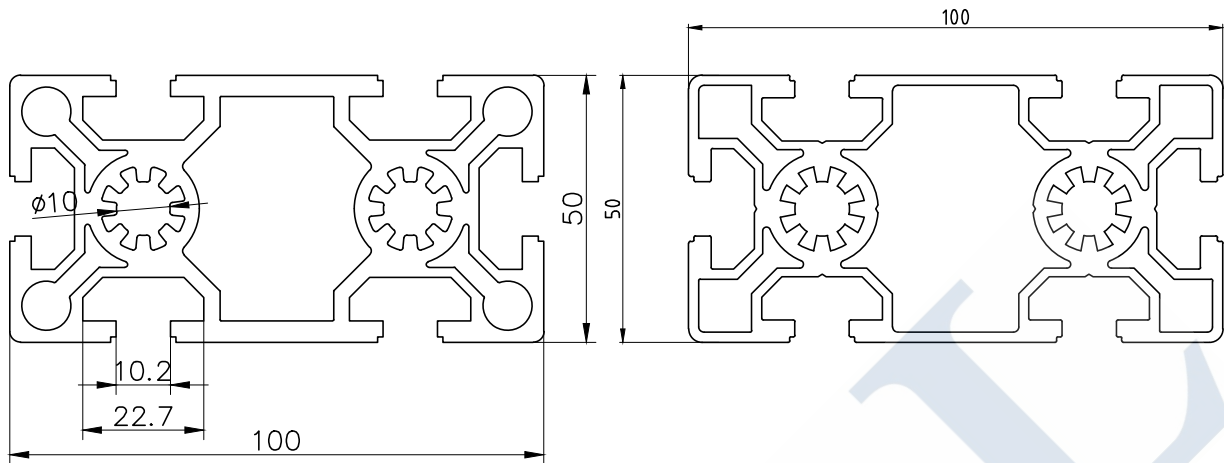

名称 Name	型号 Profile No.	壁厚 Thickness	单重(kg/m) Weight
50*100U	GYC46095		4.85

名称 Name	型号 Profile No.	壁厚 Thickness	单重(kg/m) Weight
流水线支架	GYC-JZ002	1.9	4.005

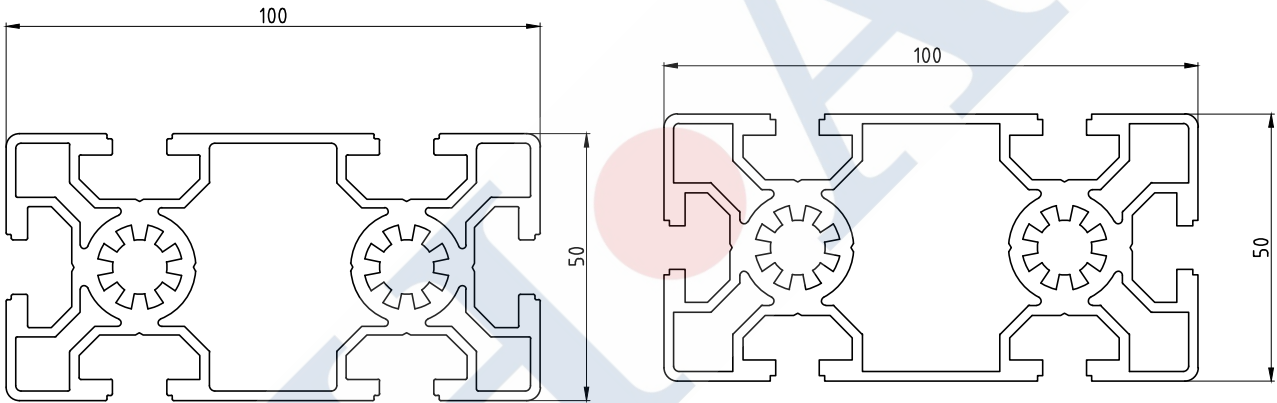

名称 Name	型号 Profile No.	壁厚 Thickness	单重(kg/m) Weight
流水线支架	GYC46380		3.907

名称 Name	型号 Profile No.	壁厚 Thickness	单重(kg/m) Weight
流水线支架	GYC46381		3.977

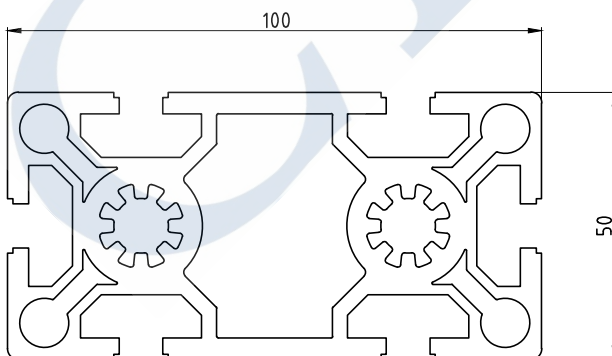

名称 Name	型号 Profile No.	壁厚 Thickness	单重(kg/m) Weight
流水线支架	GYC46382		5.191

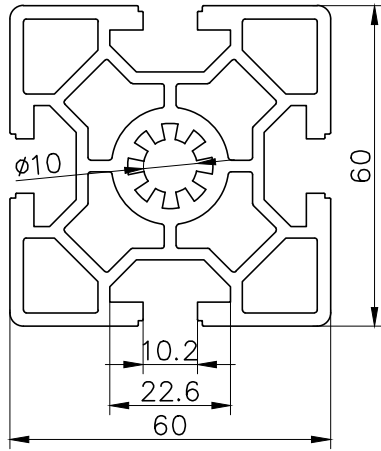

名称 Name	型号 Profile No.	壁厚 Thickness	单重(kg/m) Weight
60*60U	GYC46097	2.2	3.511

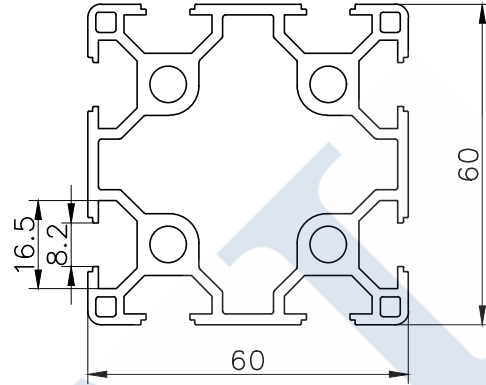

名称 Name	型号 Profile No.	壁厚 Thickness	单重(kg/m) Weight
60*60U	GYC46139	2.0	2.420

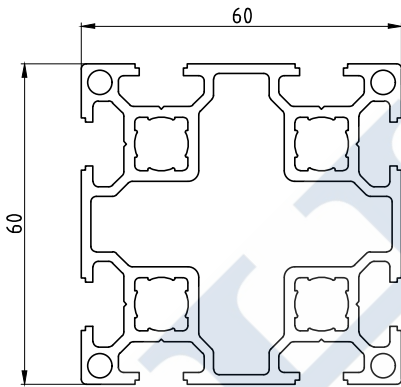

名称 Name	型号 Profile No.	壁厚 Thickness	单重(kg/m) Weight
60*60U	GYC46172		2.410

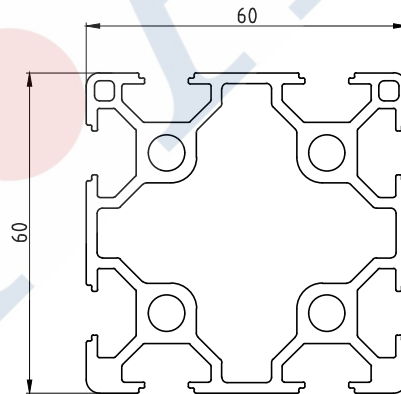

名称 Name	型号 Profile No.	壁厚 Thickness	单重(kg/m) Weight
60*60U型材	GYC46314	2.0	2.401

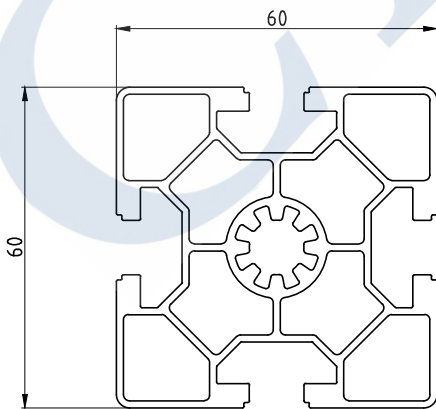

名称 Name	型号 Profile No.	壁厚 Thickness	单重(kg/m) Weight
支架	GYC46282	1.3	2.344

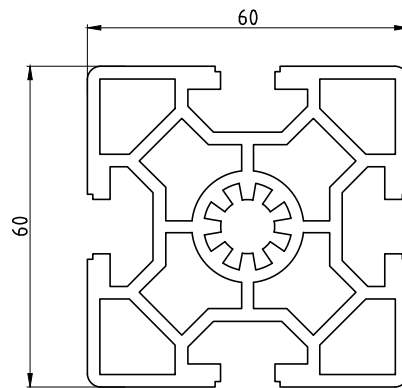

名称 Name	型号 Profile No.	壁厚 Thickness	单重(kg/m) Weight
支架	GYC-JZ005		3.389

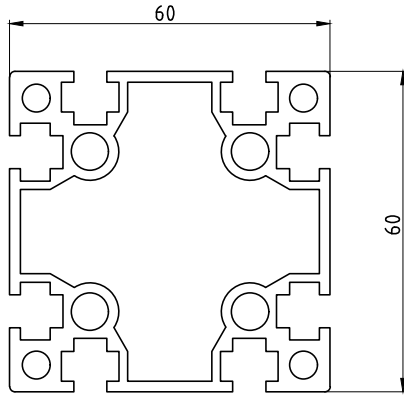

名称	型号	壁厚	单重(kg/m)
Name	Profile No.	Thickness	Weight
支架	Gyc-JZ114	1.6	2.538

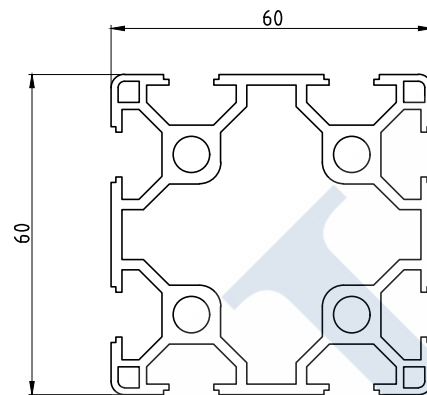

名称	型号	壁厚	单重(kg/m)
Name	Profile No.	Thickness	Weight
流水线支架	Gyc46349		2.297

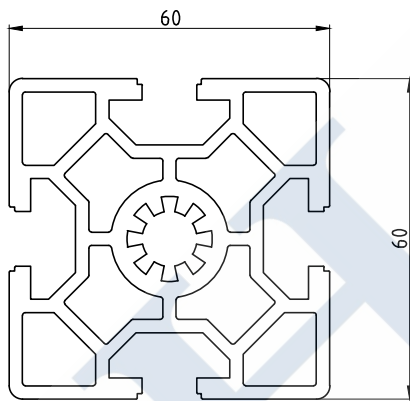

名称	型号	壁厚	单重(kg/m)
Name	Profile No.	Thickness	Weight
流水线支架	Gyc46350		3.58

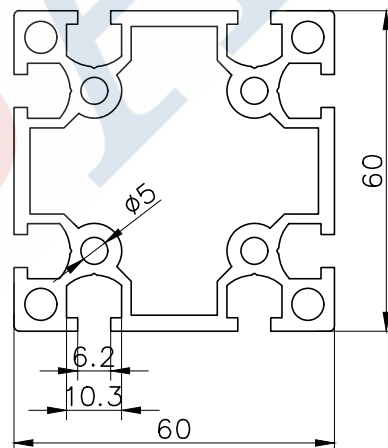

名称	型号	壁厚	单重(kg/m)
Name	Profile No.	Thickness	Weight
60*60G	Gyc46070		2.728

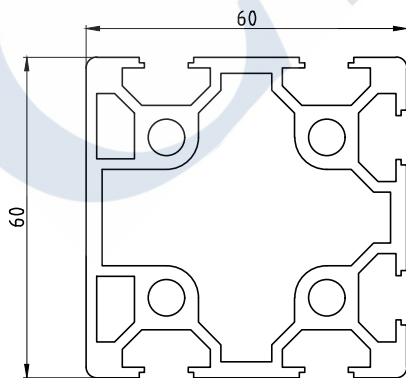

名称	型号	壁厚	单重(kg/m)
Name	Profile No.	Thickness	Weight
6060单面封	Gyc46332	2.0	2.858

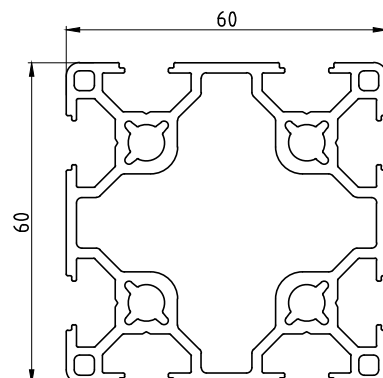

名称	型号	壁厚	单重(kg/m)
Name	Profile No.	Thickness	Weight
60*60U	Gyc46187		2.292

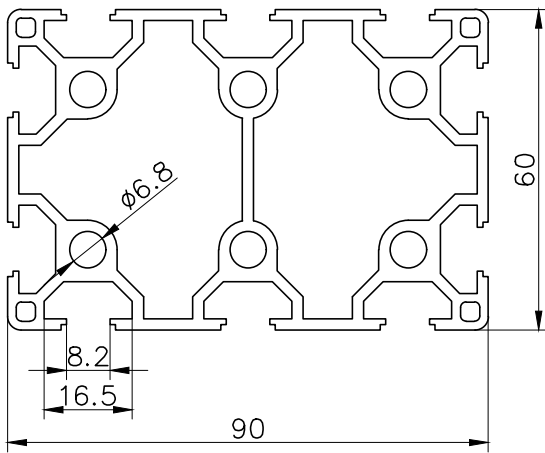

名称 Name	型号 Profile No.	壁厚 Thickness	单重(kg/m) Weight
60*90U	GYC46098	2.1	3.465

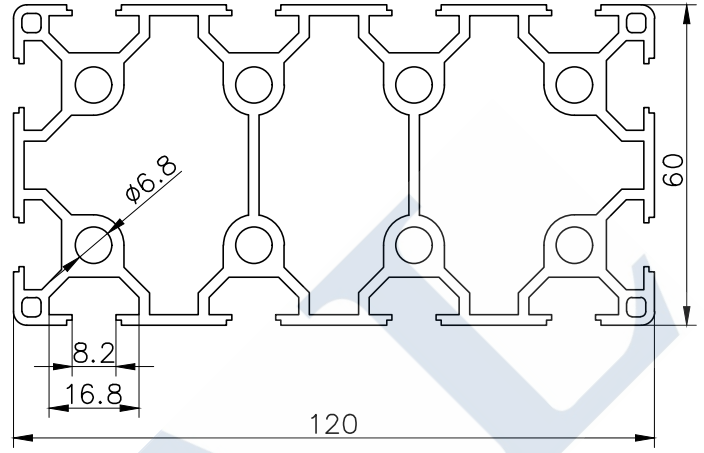

名称 Name	型号 Profile No.	壁厚 Thickness	单重(kg/m) Weight
60*120U	GYC46099	2.0	4.416

CHEER

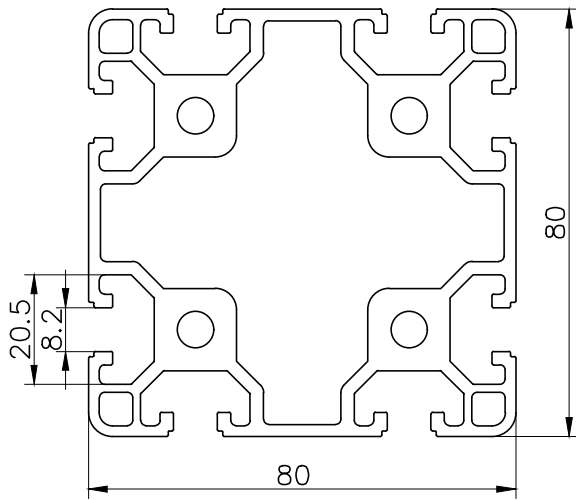

名称 Name	型号 Profile No.	壁厚 Thickness	单重(kg/m) Weight
80*80U	GYC46140	2.5	4.747

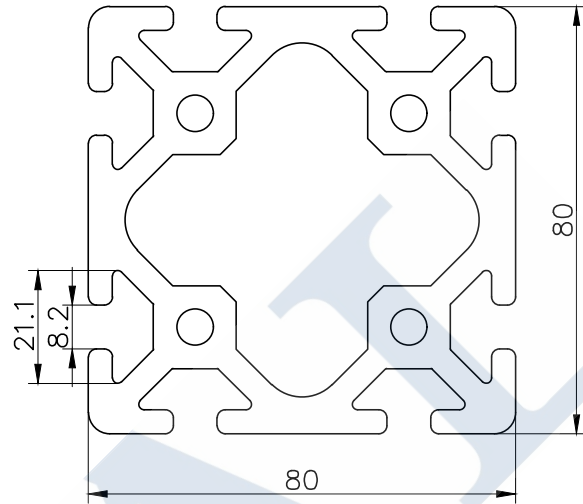

名称 Name	型号 Profile No.	壁厚 Thickness	单重(kg/m) Weight
80*80U	GYC46141	5.0	7.046

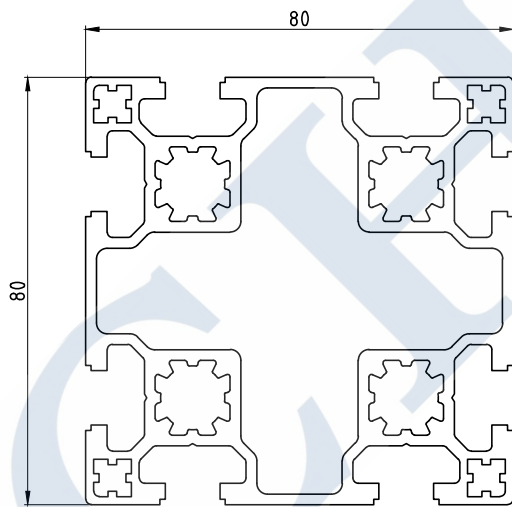

名称 Name	型号 Profile No.	壁厚 Thickness	单重(kg/m) Weight
80*80U	GYC46169	2.0	4.243

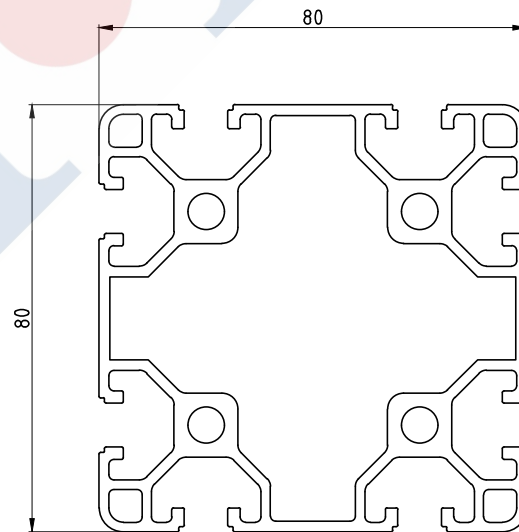

名称 Name	型号 Profile No.	壁厚 Thickness	单重(kg/m) Weight
8080J型材	GYC46315	2.0	3.665

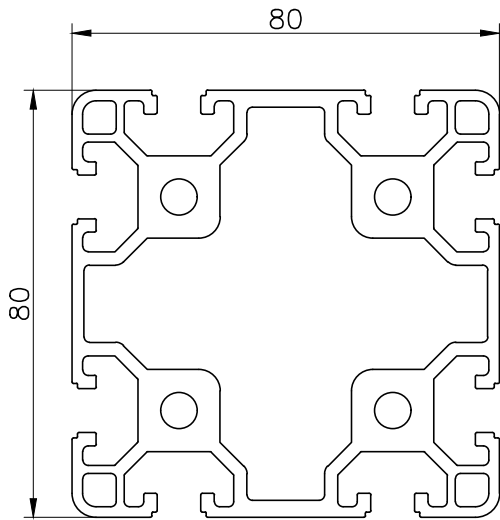

名称	型号	壁厚	单重(kg/m)
Name	Profile No.	Thickness	Weight
80*80U	GYC46177	2.5	4.843

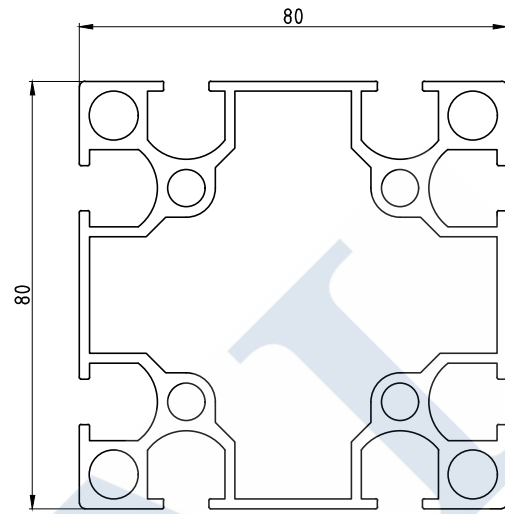

名称	型号	壁厚	单重(kg/m)
Name	Profile No.	Thickness	Weight
支架	GYC46238	1.85	3.373

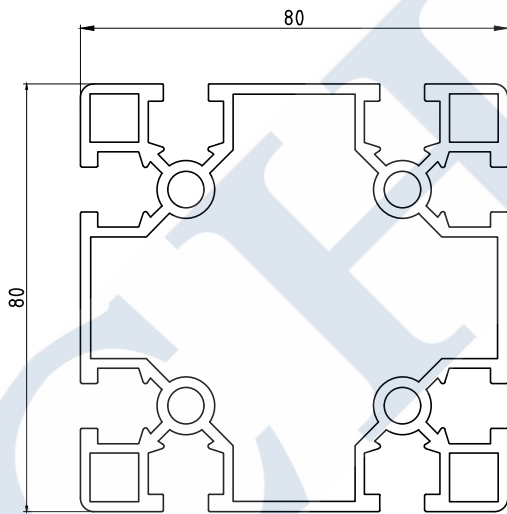

名称	型号	壁厚	单重(kg/m)
Name	Profile No.	Thickness	Weight
支架	GYC46265	1.8	3.255

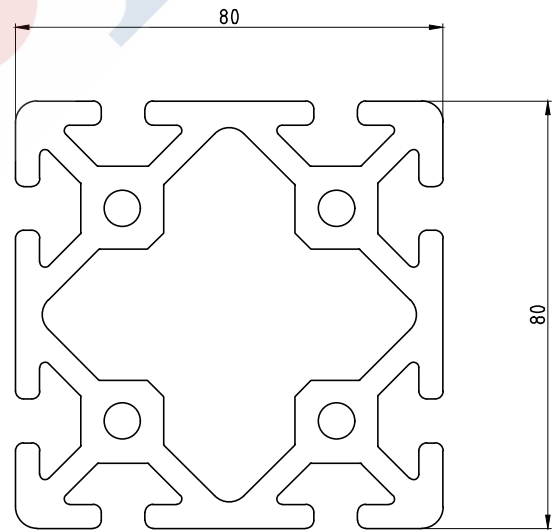

名称	型号	壁厚	单重(kg/m)
Name	Profile No.	Thickness	Weight
流水线支架	GYC46353	4.5	6.79

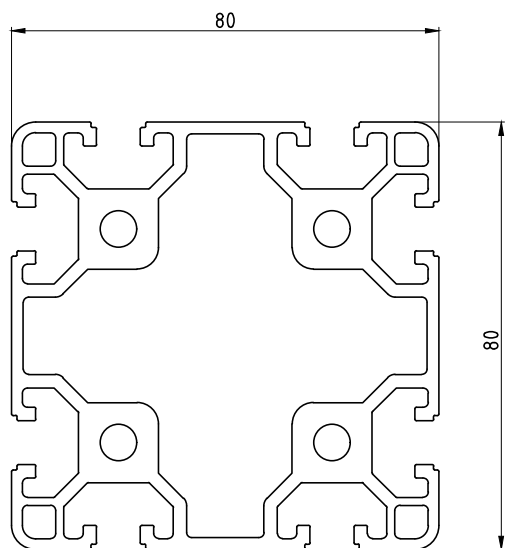

名称 Name	型号 Profile No.	壁厚 Thickness	单重(kg/m) Weight
流水线支架	GYC46352		4.655

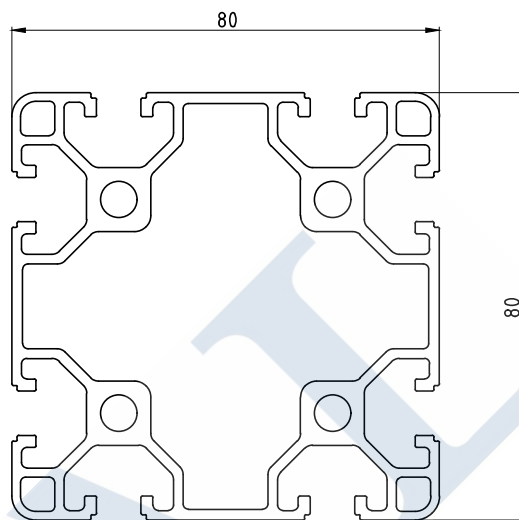

名称 Name	型号 Profile No.	壁厚 Thickness	单重(kg/m) Weight
流水线支架	GYC46351		3.61

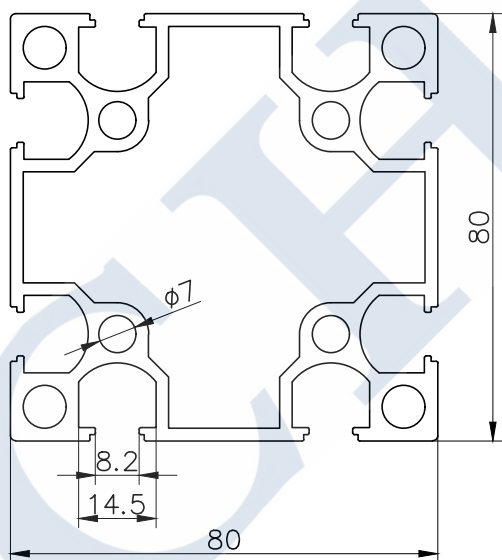

名称 Name	型号 Profile No.	壁厚 Thickness	单重(kg/m) Weight
80*80G	GYC46001	2.4	3.907

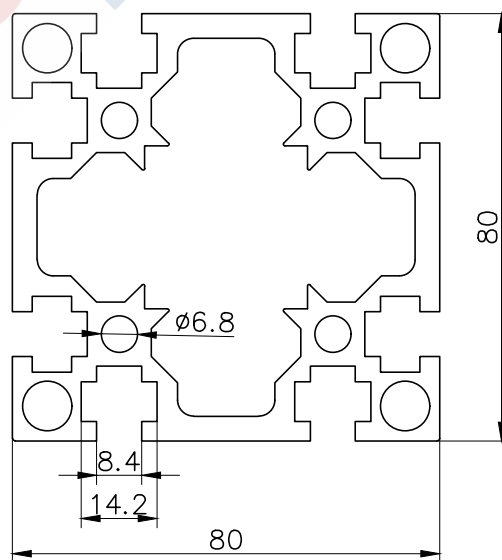

名称 Name	型号 Profile No.	壁厚 Thickness	单重(kg/m) Weight
80*80G	GYC46100		5.214

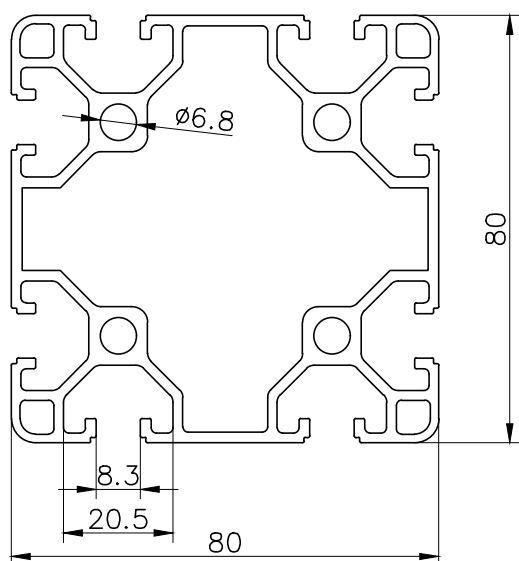

名称 Name	型号 Profile No.	壁厚 Thickness	单重(kg/m) Weight
80*80U	GYC46065		3.388

CH·AL

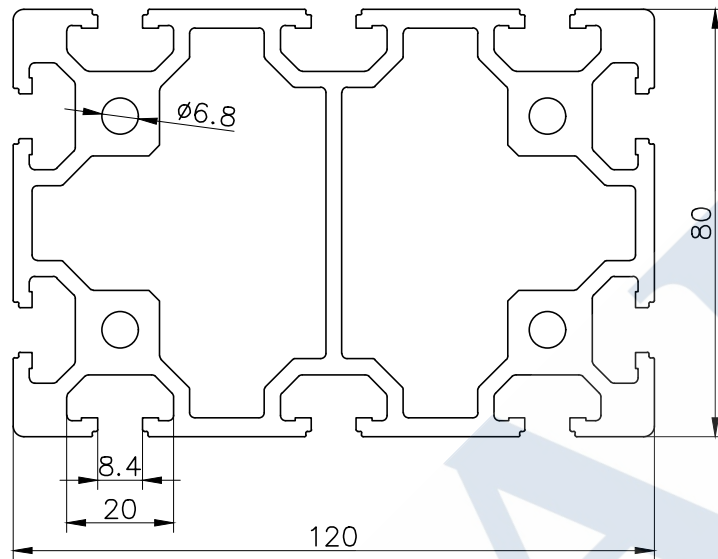

名称 Name	型号 Profile No.	壁厚 Thickness	单重(kg/m) Weight
80*120U	GYC46101		7.346

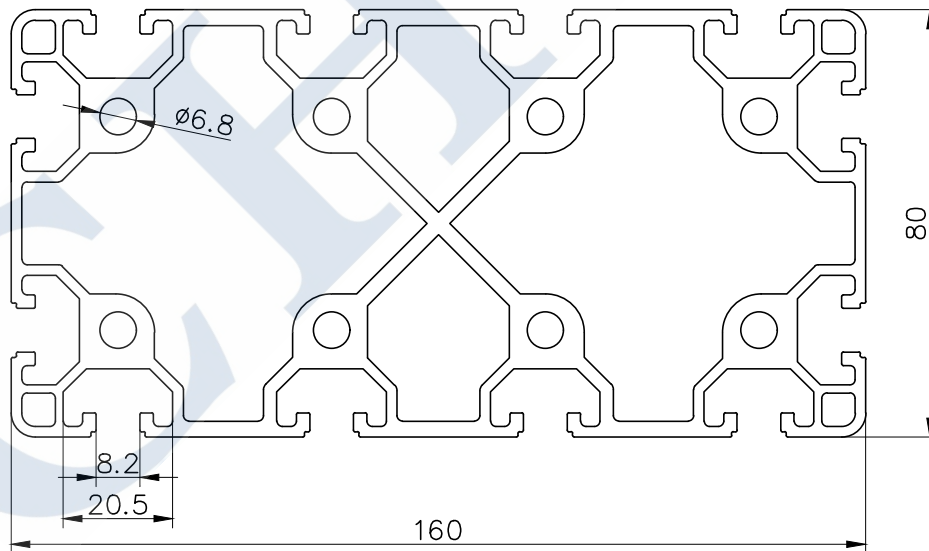

名称 Name	型号 Profile No.	壁厚 Thickness	单重(kg/m) Weight
80*160U	GYC46102	2.0	8.013

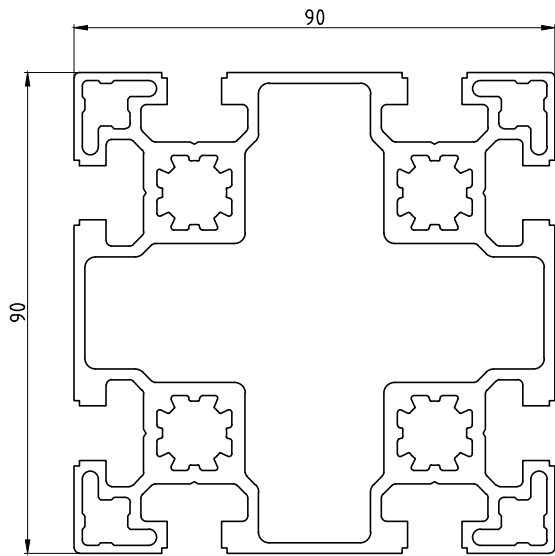

名称	型号	壁厚	单重(kg/m)
Name	Profile No.	Thickness	Weight
90*90U	GYC46168	2.0	5.225

CH·AL

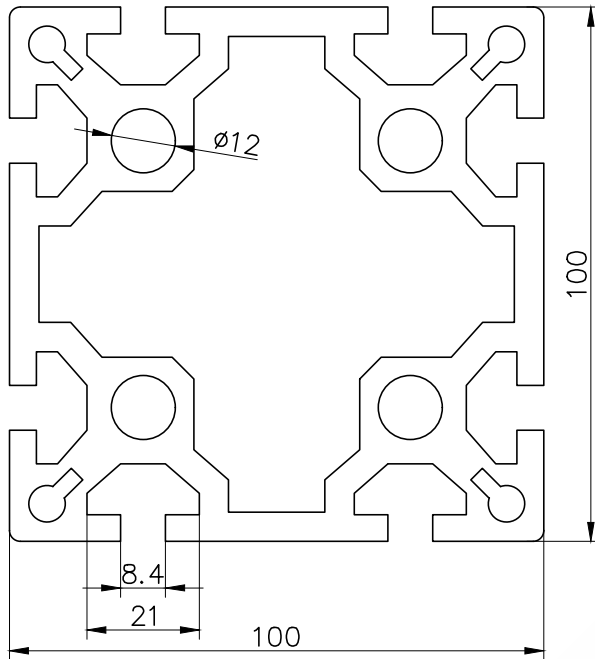

名称 Name	型号 Profile No.	壁厚 Thickness	单重(kg/m) Weight
100*100U	GYC46103	5.5	9.645

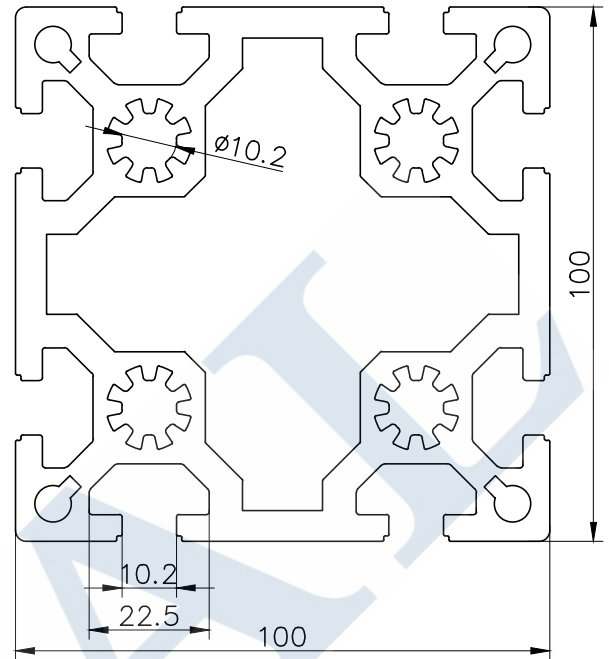

名称 Name	型号 Profile No.	壁厚 Thickness	单重(kg/m) Weight
100*100U	GYC46104	5.8	9.521

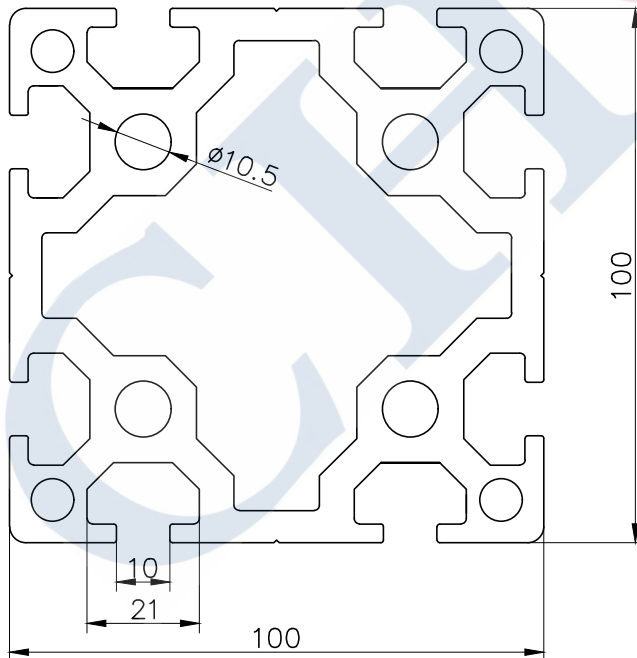

名称 Name	型号 Profile No.	壁厚 Thickness	单重(kg/m) Weight
100*100U	GYC46014		9.612

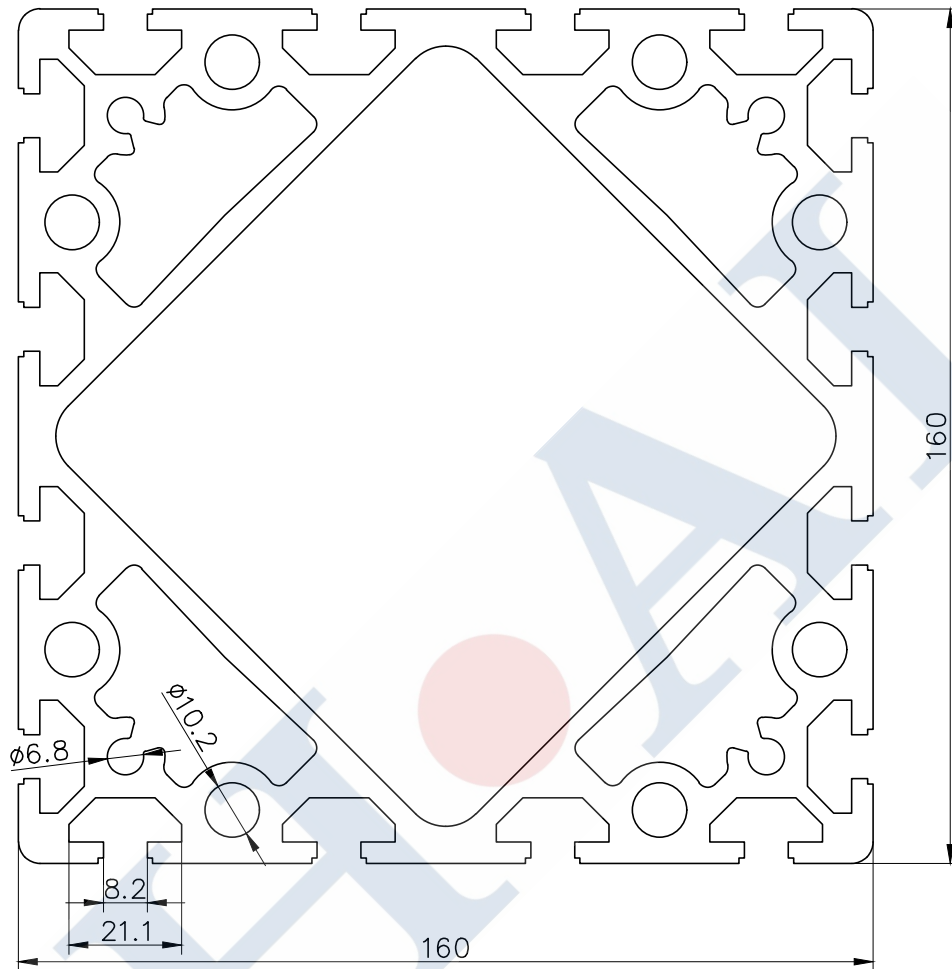

名称 Name	型号 Profile No.	壁厚 Thickness	单重(kg/m) Weight
160*160U	GYC46145		18.362

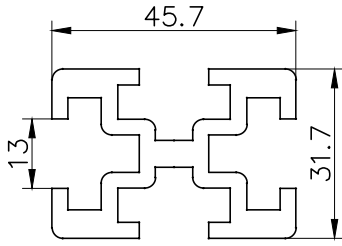

名称 Name	型号 Profile No.	壁厚 Thickness	单重(kg/m) Weight
辅材	HJG-30		1.614

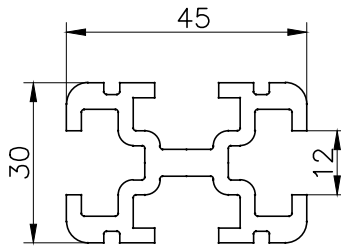

名称 Name	型号 Profile No.	壁厚 Thickness	单重(kg/m) Weight
	HJG-76		1.365

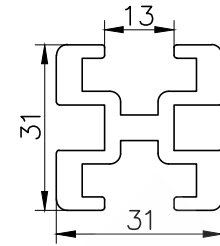

名称 Name	型号 Profile No.	壁厚 Thickness	单重(kg/m) Weight
	HJG-575		1.103

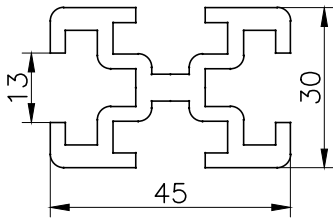

名称 Name	型号 Profile No.	壁厚 Thickness	单重(kg/m) Weight
	HJG-141	3.0	1.417

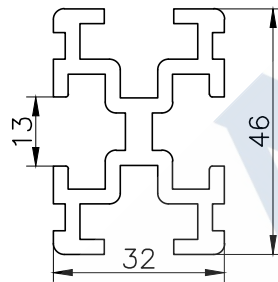

名称 Name	型号 Profile No.	壁厚 Thickness	单重(kg/m) Weight
	HJG-212	2.8	1.425

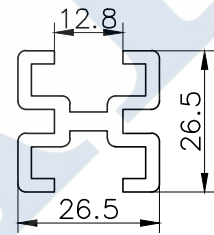

名称 Name	型号 Profile No.	壁厚 Thickness	单重(kg/m) Weight
	HJG-372	2.5	0.734

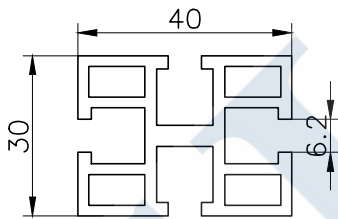

名称 Name	型号 Profile No.	壁厚 Thickness	单重(kg/m) Weight
	HJG618	2.0	1.258

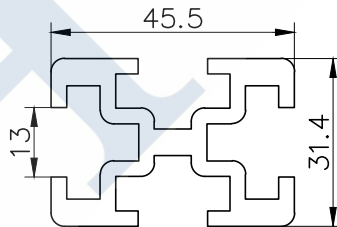

名称 Name	型号 Profile No.	壁厚 Thickness	单重(kg/m) Weight
	HJG-373	2.9	1.532

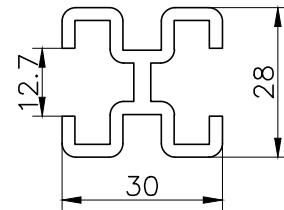

名称 Name	型号 Profile No.	壁厚 Thickness	单重(kg/m) Weight
	HJG-930	2.4	0.749

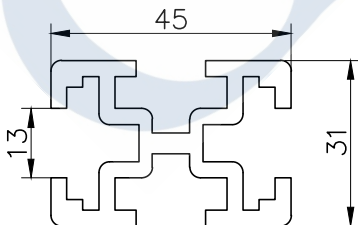

名称 Name	型号 Profile No.	壁厚 Thickness	单重(kg/m) Weight
	HJG-1163	3.0	1.436

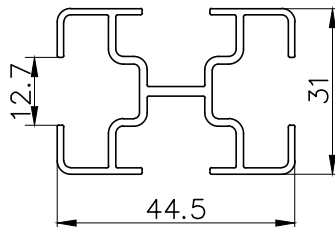

名称 Name	型号 Profile No.	壁厚 Thickness	单重(kg/m) Weight
	HJG-969	1.2	0.63

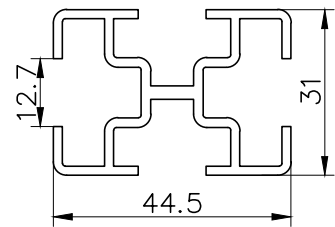

名称 Name	型号 Profile No.	壁厚 Thickness	单重(kg/m) Weight
	HJG-929	1.7	0.835

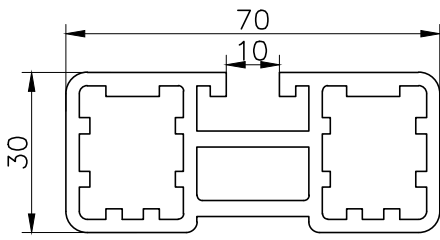

名称 Name	型号 Profile No.	壁厚 Thickness	单重(kg/m) Weight
	HJG-963	2.5	2.044

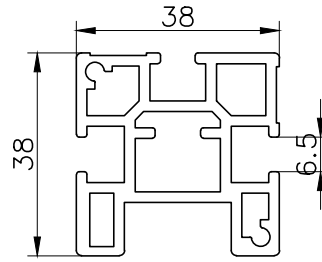

名称 Name	型号 Profile No.	壁厚 Thickness	单重(kg/m) Weight
	HJG-961	2.0	1.329

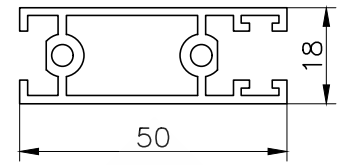

名称 Name	型号 Profile No.	壁厚 Thickness	单重(kg/m) Weight
	GYC46007	1.5	0.742

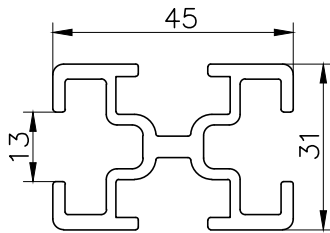

名称 Name	型号 Profile No.	壁厚 Thickness	单重(kg/m) Weight
	HJG-1260		1.089

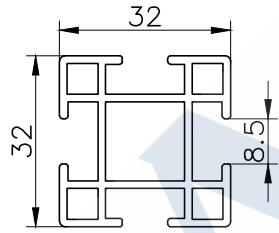

名称 Name	型号 Profile No.	壁厚 Thickness	单重(kg/m) Weight
	HJG-1261	1.4	0.772

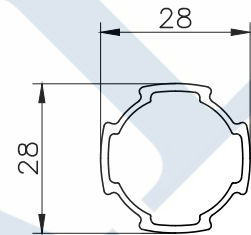

名称 Name	型号 Profile No.	壁厚 Thickness	单重(kg/m) Weight
	GYC46038	1.1	0.346

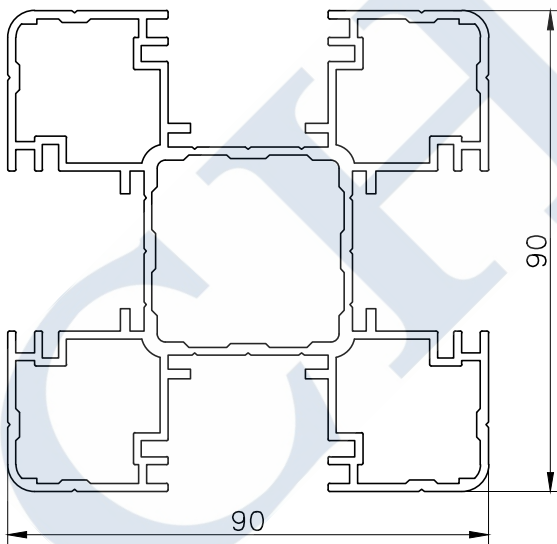

名称 Name	型号 Profile No.	壁厚 Thickness	单重(kg/m) Weight
	EX-CA-061	1.5	3.043

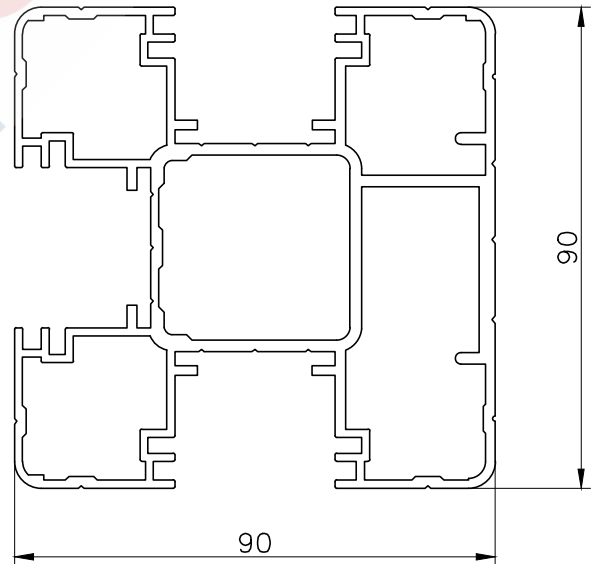

名称 Name	型号 Profile No.	壁厚 Thickness	单重(kg/m) Weight
	EX-CA-034	1.5	3.338

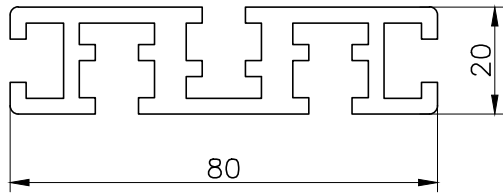

名称 Name	型号 Profile No.	壁厚 Thickness	单重(kg/m) Weight
	GYC46006		2.002

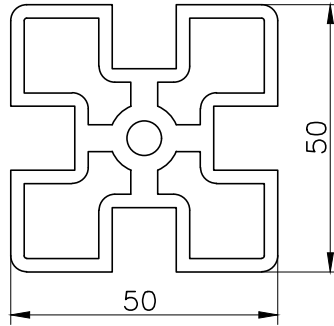

名称 Name	型号 Profile No.	壁厚 Thickness	单重(kg/m) Weight
	GYC05074	2.5	2.397

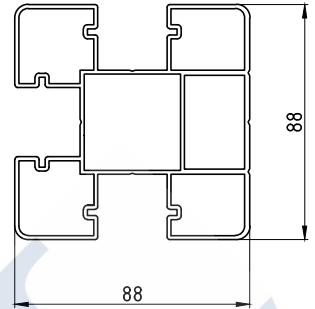

名称 Name	型号 Profile No.	壁厚 Thickness	单重(kg/m) Weight
	EX-CA-001	1.5	2.798

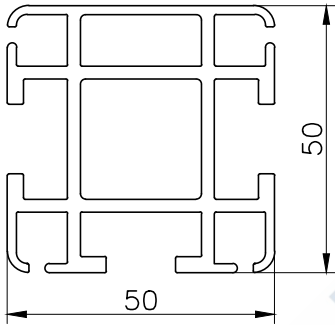

名称 Name	型号 Profile No.	壁厚 Thickness	单重(kg/m) Weight
	HJG-1180	2.4	1.872

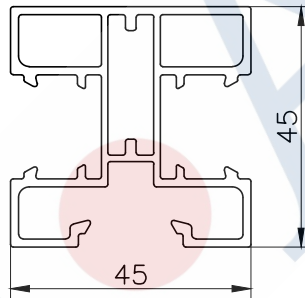

名称 Name	型号 Profile No.	壁厚 Thickness	单重(kg/m) Weight
	EX-IND-403	1.5	1.136

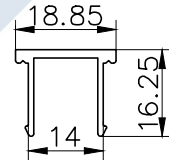

名称 Name	型号 Profile No.	壁厚 Thickness	单重(kg/m) Weight
	EX-IND-255	1.0	0.169

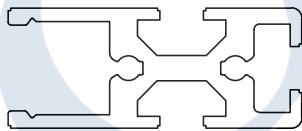

名称 Name	型号 Profile No.	壁厚 Thickness	单重(kg/m) Weight
TS1流水线型材	GYC46204		1.361

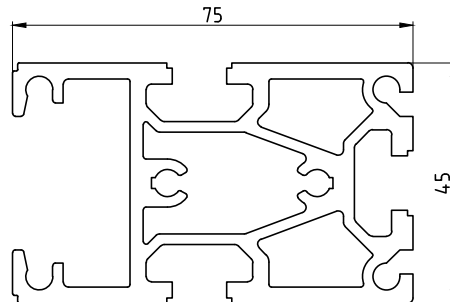

名称 Name	型号 Profile No.	壁厚 Thickness	单重(kg/m) Weight
90*90U	GYC46205	2.0	2.820

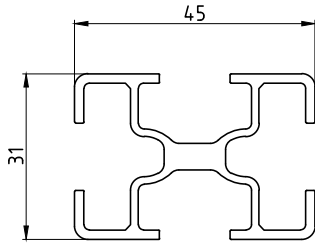

名称 Name	型号 Profile No.	壁厚 Thickness	单重(kg/m) Weight
支架料	GYC46229	1.75	0.833

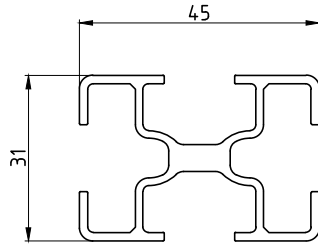

名称 Name	型号 Profile No.	壁厚 Thickness	单重(kg/m) Weight
支架料	GYC46230	1.6	0.8

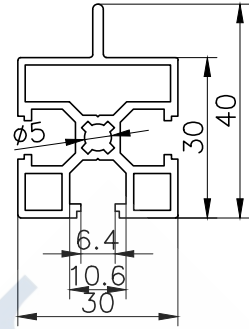

名称 Name	型号 Profile No.	壁厚 Thickness	单重(kg/m) Weight
30*30G	GYC46047	1.4	0.787

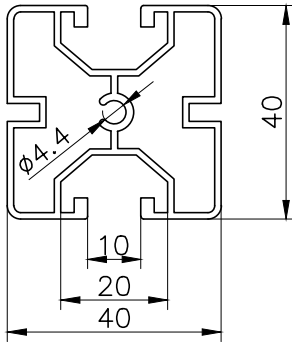

名称 Name	型号 Profile No.	壁厚 Thickness	单重(kg/m) Weight
40*40U	GYC46018	1.2	0.902

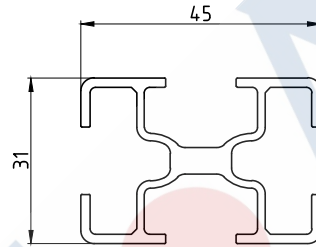

名称 Name	型号 Profile No.	壁厚 Thickness	单重(kg/m) Weight
支架料	GYC46229	1.75	0.833

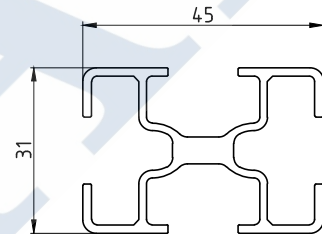

名称 Name	型号 Profile No.	壁厚 Thickness	单重(kg/m) Weight
支架料	GYC46230	1.6	0.8

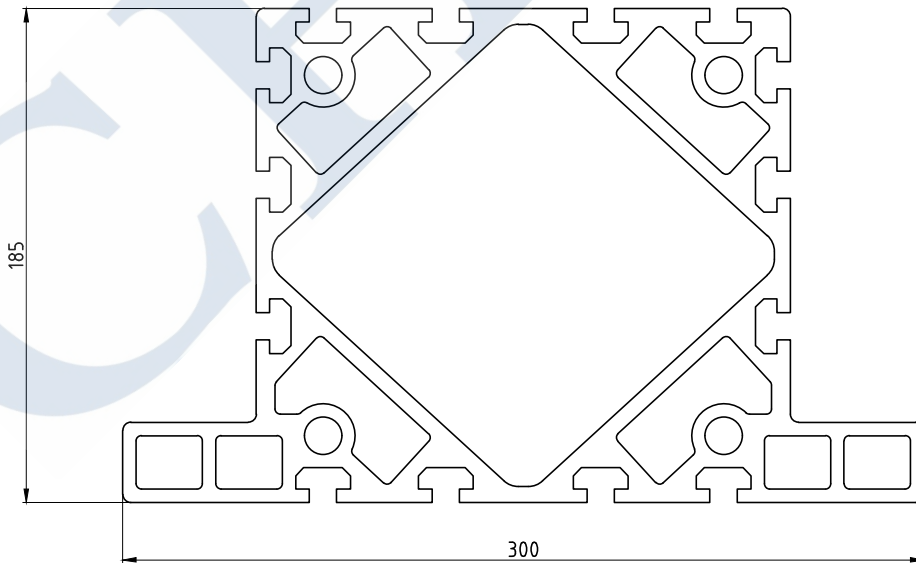

此型材比例为1:2

名称 Name	型号 Profile No.	壁厚 Thickness	单重(kg/m) Weight
支架	GYC46237	5.0	30.808

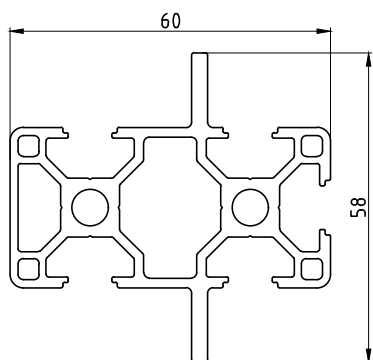

名称 Name	型号 Profile No.	壁厚 Thickness	单重(kg/m) Weight
3060短边封	GYC46333		1.688

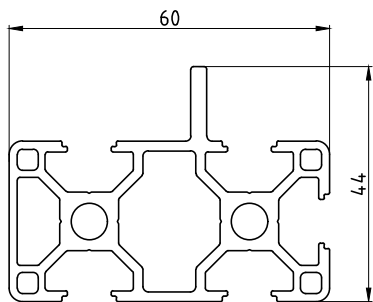

名称 Name	型号 Profile No.	壁厚 Thickness	单重(kg/m) Weight
3060短边封	GYC46334		1.573

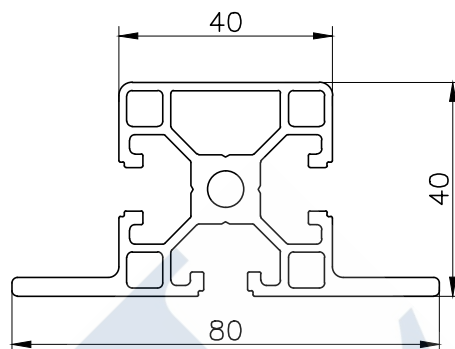

名称 Name	型号 Profile No.	壁厚 Thickness	单重(kg/m) Weight
4040单面封	GYC46325	1.5	1.773

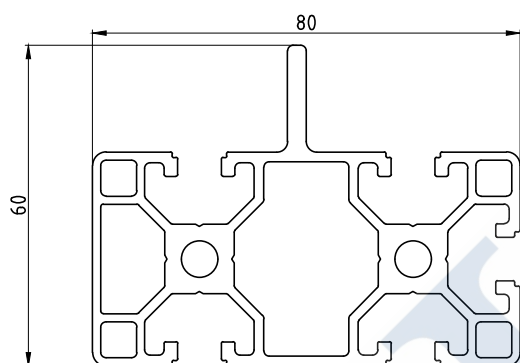

名称 Name	型号 Profile No.	壁厚 Thickness	单重(kg/m) Weight
4080短边封	GYC46326	1.8	2.595

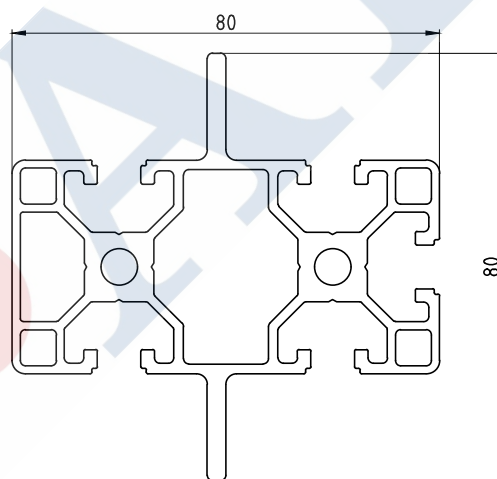

名称 Name	型号 Profile No.	壁厚 Thickness	单重(kg/m) Weight
4080短边封	GYC46327	1.8	2.788

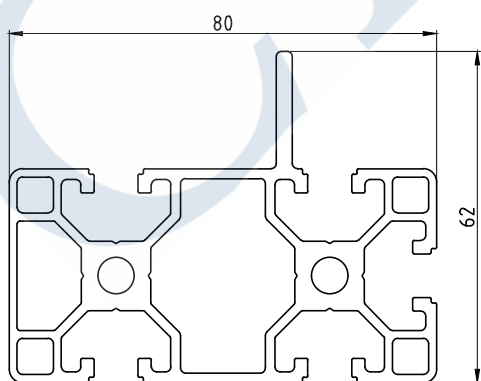

名称 Name	型号 Profile No.	壁厚 Thickness	单重(kg/m) Weight
6060单面封	GYC46328	1.8	2.580

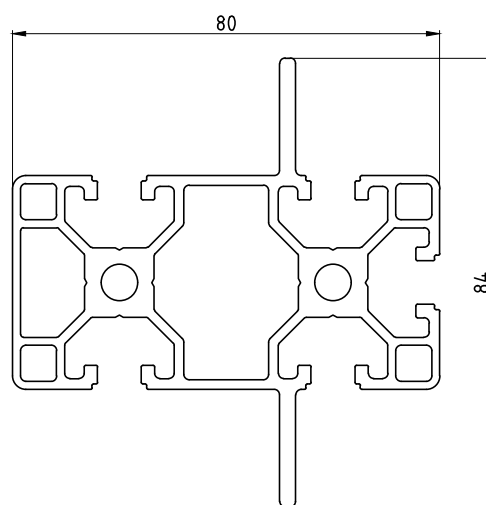

名称 Name	型号 Profile No.	壁厚 Thickness	单重(kg/m) Weight
6060单面封	GYC46329	1.8	2.759

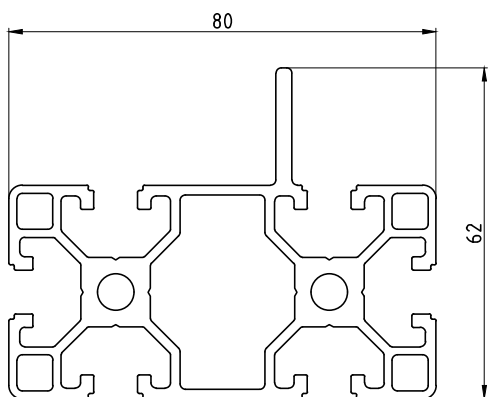

名称 Name	型号 Profile No.	壁厚 Thickness	单重(kg/m) Weight
6060单面封	GYC46330	1.8	2.594

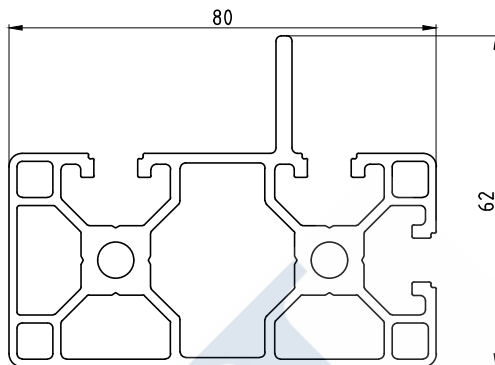

名称 Name	型号 Profile No.	壁厚 Thickness	单重(kg/m) Weight
4080邻边封	GYC46331	1.8	2.555

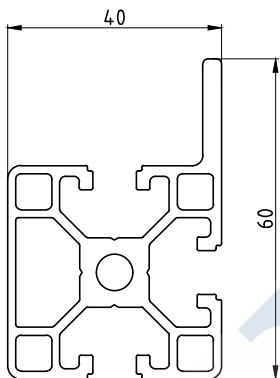

名称 Name	型号 Profile No.	壁厚 Thickness	单重(kg/m) Weight
4040单面封	GYC46324	1.5	1.578

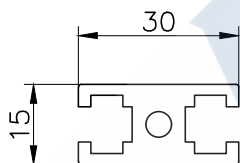

名称 Name	型号 Profile No.	壁厚 Thickness	单重(kg/m) Weight
30*15U	GYC46181		0.672

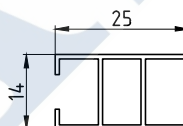

名称 Name	型号 Profile No.	壁厚 Thickness	单重(kg/m) Weight
支架	GYC46251	0.8	0.188

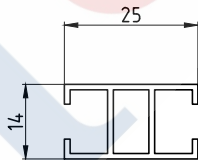

名称 Name	型号 Profile No.	壁厚 Thickness	单重(kg/m) Weight
支架	GYC46252	1.05	0.241

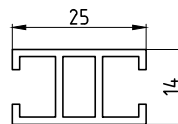

名称 Name	型号 Profile No.	壁厚 Thickness	单重(kg/m) Weight
支架	GYC-JZ096	1.35	0.301

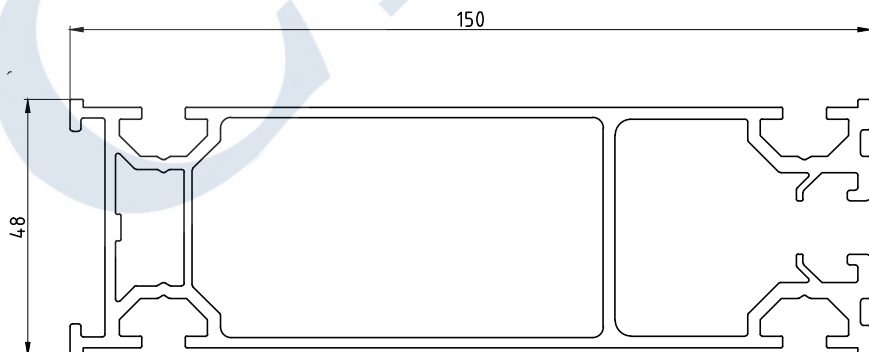

名称 Name	型号 Profile No.	壁厚 Thickness	单重(kg/m) Weight
支架料	GYC46200	1.9	3.163

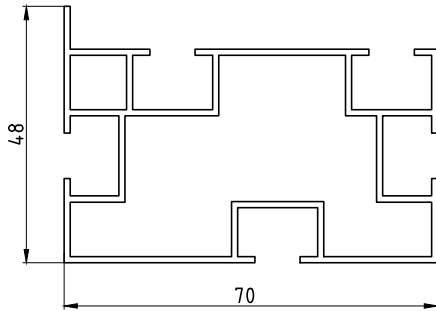

名称 Name	型号 Profile No.	壁厚 Thickness	单重(kg/m) Weight
支架	GYC46241	1.15	1.065

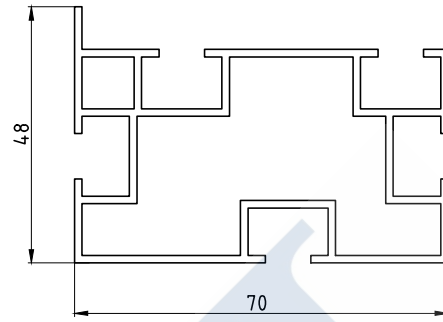

名称 Name	型号 Profile No.	壁厚 Thickness	单重(kg/m) Weight
支架	GYC46244	1.4	1.287

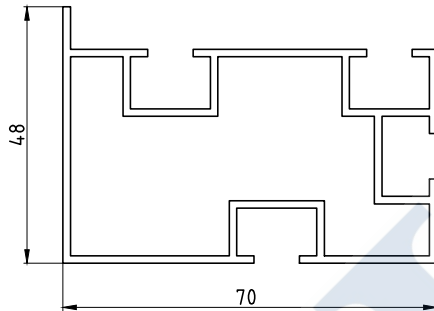

名称 Name	型号 Profile No.	壁厚 Thickness	单重(kg/m) Weight
支架	GYC46249	1.4	1.186

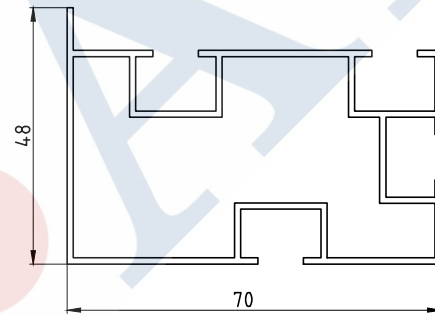

名称 Name	型号 Profile No.	壁厚 Thickness	单重(kg/m) Weight
支架	GYC46250	1.15	0.98

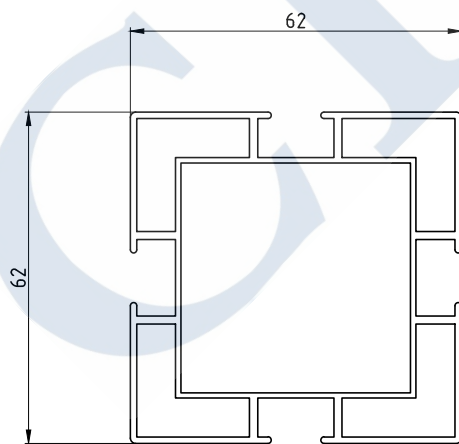

名称 Name	型号 Profile No.	壁厚 Thickness	单重(kg/m) Weight
支架	GYC46253	1.2	1.379

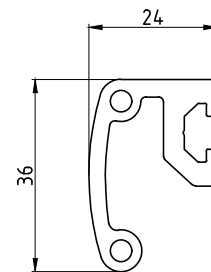

名称 Name	型号 Profile No.	壁厚 Thickness	单重(kg/m) Weight
	GYC46283		0.801

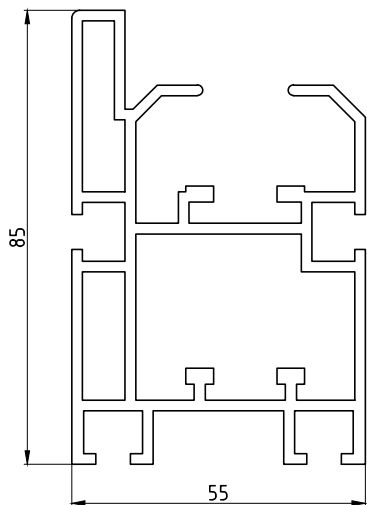

名称 Name	型号 Profile No.	壁厚 Thickness	单重(kg/m) Weight
支架	GYC46256	2.0	2.437

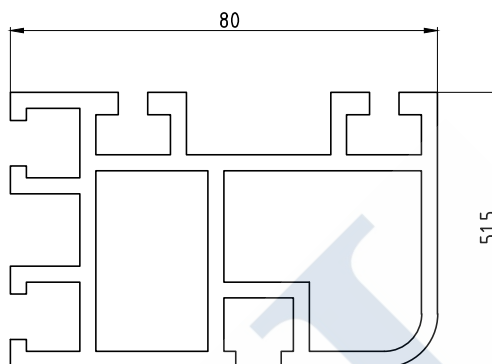

名称 Name	型号 Profile No.	壁厚 Thickness	单重(kg/m) Weight
支架	GYC46258	3	3.096

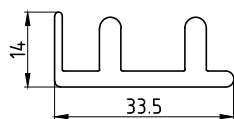

名称 Name	型号 Profile No.	壁厚 Thickness	单重(kg/m) Weight
	GYC46284		0.518

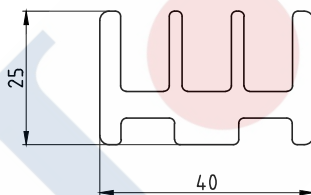

名称 Name	型号 Profile No.	壁厚 Thickness	单重(kg/m) Weight
	GYC46285	2.4	1.319

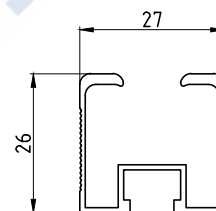

名称 Name	型号 Profile No.	壁厚 Thickness	单重(kg/m) Weight
	GYC46288	1	0.33

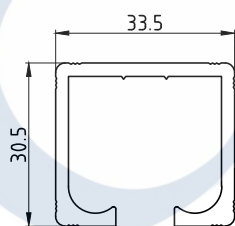

名称 Name	型号 Profile No.	壁厚 Thickness	单重(kg/m) Weight
	GYC46289	2.4	0.735

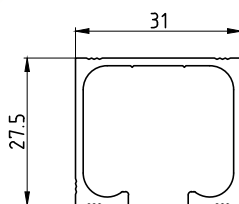

名称 Name	型号 Profile No.	壁厚 Thickness	单重(kg/m) Weight
	GYC46290	1.4	0.438

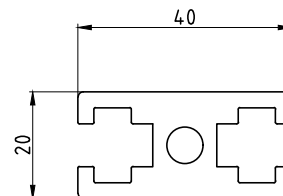

名称 Name	型号 Profile No.	壁厚 Thickness	单重(kg/m) Weight
支架	GYC46298	3.0	1.232

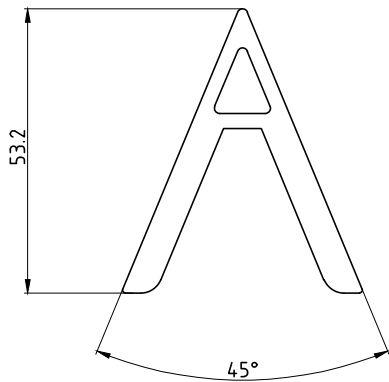

名称 Name	型号 Profile No.	壁厚 Thickness	单重(kg/m) Weight
连接件	GYC-JZ051		1.491

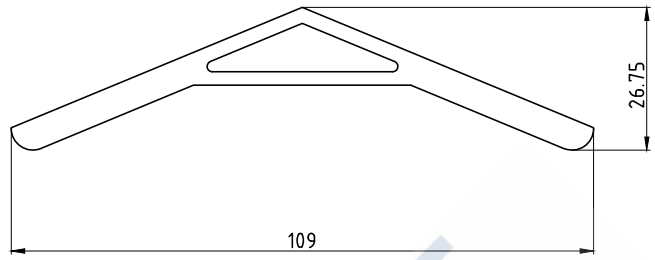

名称 Name	型号 Profile No.	壁厚 Thickness	单重(kg/m) Weight
连接件	GYC-JZ049		1.725

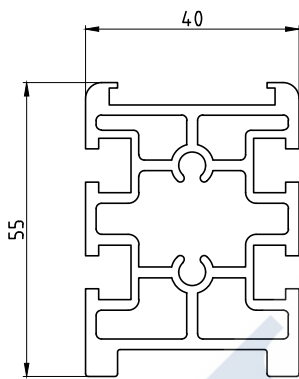

名称 Name	型号 Profile No.	壁厚 Thickness	单重(kg/m) Weight
流水线支架	GYC-JZ073		1.857

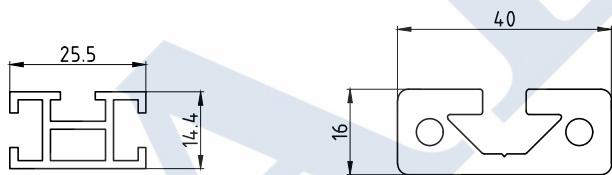

名称 Name	型号 Profile No.	壁厚 Thickness	单重(kg/m) Weight
支架	GYC-JZ072		0.355

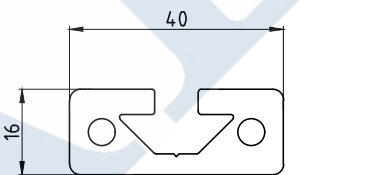

名称 Name	型号 Profile No.	壁厚 Thickness	单重(kg/m) Weight
支架	GYC-JZ053		1.206

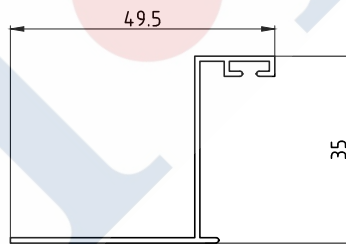

名称 Name	型号 Profile No.	壁厚 Thickness	单重(kg/m) Weight
扇料	GYC-JZ009		0.263

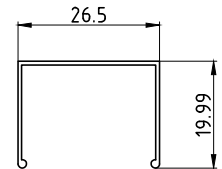

名称 Name	型号 Profile No.	壁厚 Thickness	单重(kg/m) Weight
线槽	GYC-JZ019		0.129

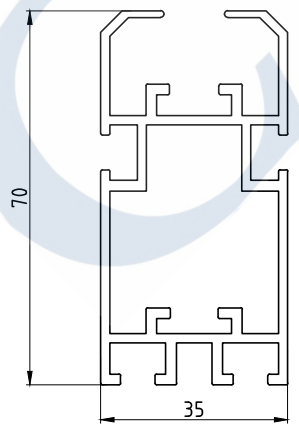

名称 Name	型号 Profile No.	壁厚 Thickness	单重(kg/m) Weight
机身	GYC-JZ047		1.398

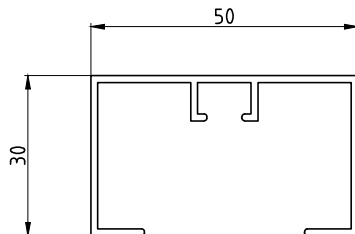

名称 Name	型号 Profile No.	壁厚 Thickness	单重(kg/m) Weight
线槽	GYC-JZ020	1.9	0.502

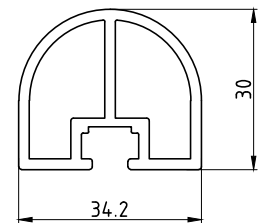

名称 Name	型号 Profile No.	壁厚 Thickness	单重(kg/m) Weight
装饰块	GYC-JZ041		0.778

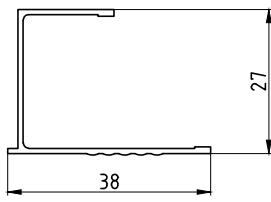

名称 Name	型号 Profile No.	壁厚 Thickness	单重(kg/m) Weight
宽边槽	GYC-JZ070		0.232

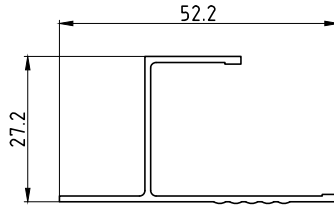

名称 Name	型号 Profile No.	壁厚 Thickness	单重(kg/m) Weight
宽边门框	GYC-JZ069		0.296

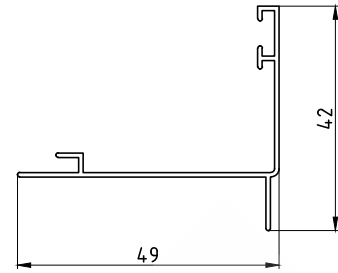

名称 Name	型号 Profile No.	壁厚 Thickness	单重(kg/m) Weight
框料	GYC-JZ068		0.251

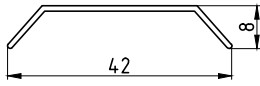

名称 Name	型号 Profile No.	壁厚 Thickness	单重(kg/m) Weight
线槽	GYC-JZ071		0.13

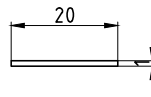

名称 Name	型号 Profile No.	壁厚 Thickness	单重(kg/m) Weight
铝排	GYC-JZ027		0.054

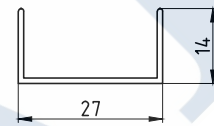

名称 Name	型号 Profile No.	壁厚 Thickness	单重(kg/m) Weight
U铝	GYC-JZ090	1	0.143

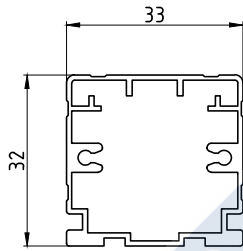

名称 Name	型号 Profile No.	壁厚 Thickness	单重(kg/m) Weight
拉杆	GYC-JZ086		0.556

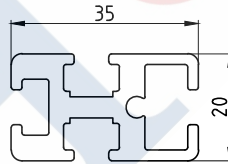

名称 Name	型号 Profile No.	壁厚 Thickness	单重(kg/m) Weight
支架	GYC-JZ092		0.898

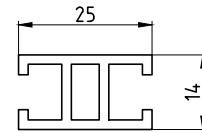

名称 Name	型号 Profile No.	壁厚 Thickness	单重(kg/m) Weight
支架	GYC-JZ095	1.8	0.383

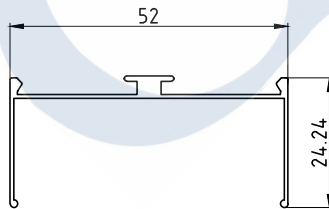

名称 Name	型号 Profile No.	壁厚 Thickness	单重(kg/m) Weight
压线座	GYC-JZ097	0.7	0.263

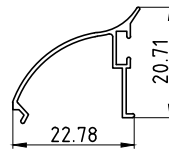

名称 Name	型号 Profile No.	壁厚 Thickness	单重(kg/m) Weight
压线	GYC-JZ099	0.7	0.118

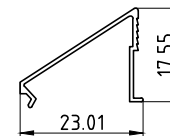

名称 Name	型号 Profile No.	壁厚 Thickness	单重(kg/m) Weight
压线	GYC-JZ098	0.7	0.101

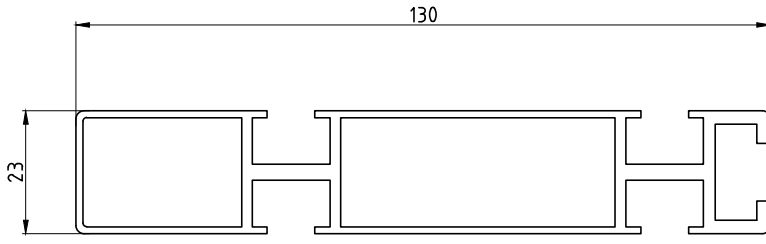

名称	型号	壁厚	单重(kg/m)
Name	Profile No.	Thickness	Weight
支架	GYC-JZ102	1.3	1.663

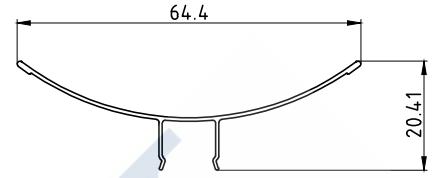

名称	型号	壁厚	单重(kg/m)
Name	Profile No.	Thickness	Weight
	GYC-JZ118		0.169

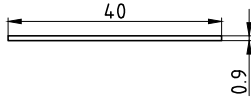

名称	型号	壁厚	单重(kg/m)
Name	Profile No.	Thickness	Weight
铝排	GYC-JZ100		0.098



名称	型号	壁厚	单重(kg/m)
Name	Profile No.	Thickness	Weight
支架	GYC-JZ109	0.8	0.223

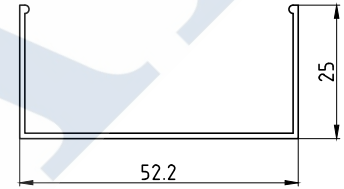

名称	型号	壁厚	单重(kg/m)
Name	Profile No.	Thickness	Weight
支架	GYC-JZ110	1.0	0.277

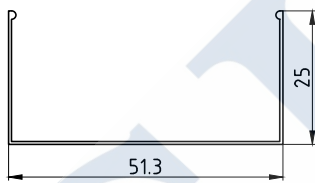

名称	型号	壁厚	单重(kg/m)
Name	Profile No.	Thickness	Weight
支架	GYC-JZ111	0.55	0.155

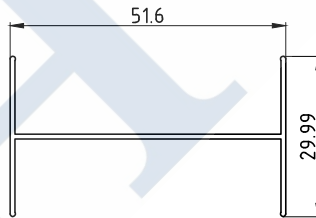

名称	型号	壁厚	单重(kg/m)
Name	Profile No.	Thickness	Weight
支架	GYC-JZ112	0.9	0.267

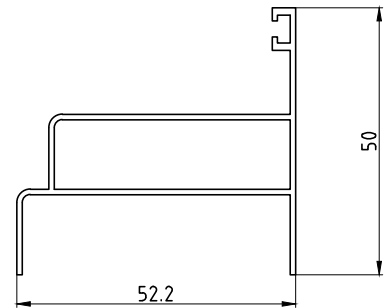

名称	型号	壁厚	单重(kg/m)
Name	Profile No.	Thickness	Weight
支架	GYC-JZ113	1.0	0.5

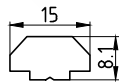

名称	型号	壁厚	单重(kg/m)
Name	Profile No.	Thickness	Weight
滑块	GYC-JZ101		0.265

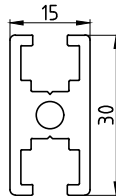

名称	型号	壁厚	单重(kg/m)
Name	Profile No.	Thickness	Weight
流水线支架	GYC46366		0.622

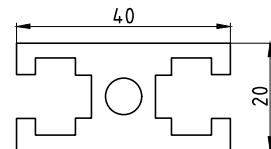

名称	型号	壁厚	单重(kg/m)
Name	Profile No.	Thickness	Weight
流水线支架	GYC46369		1.199

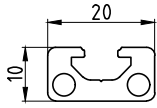

名称 Name	型号 Profile No.	壁厚 Thickness	单重(kg/m) Weight
流水线支架	GYC46385		0.32

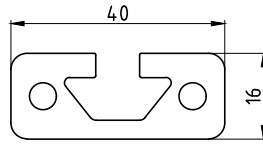

名称 Name	型号 Profile No.	壁厚 Thickness	单重(kg/m) Weight
流水线支架	GYC46388		1.17

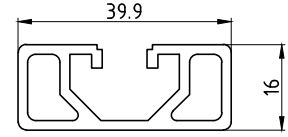

名称 Name	型号 Profile No.	壁厚 Thickness	单重(kg/m) Weight
流水线支架	GYC46387		0.658

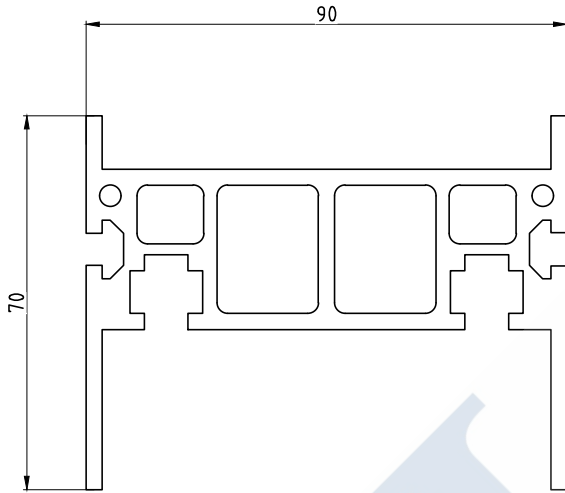

名称 Name	型号 Profile No.	壁厚 Thickness	单重(kg/m) Weight
长U弯	GYC46335	3.0	3.491

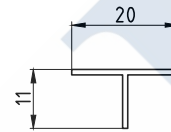

名称 Name	型号 Profile No.	壁厚 Thickness	单重(kg/m) Weight
T型铝	GYC-JZ036	1	0.081

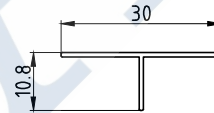

名称 Name	型号 Profile No.	壁厚 Thickness	单重(kg/m) Weight
T型铝	GYC-JZ038	0.8	0.087

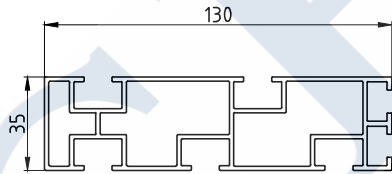

此型材比例为1:2

名称 Name	型号 Profile No.	壁厚 Thickness	单重(kg/m) Weight
支架料	GYC-JZ050	1.6	2.236

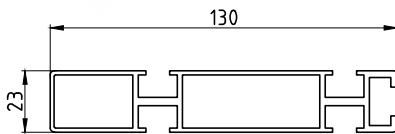

此型材比例为1:2

名称 Name	型号 Profile No.	壁厚 Thickness	单重(kg/m) Weight
支架料	GYC-JZ043	1.5	1.764

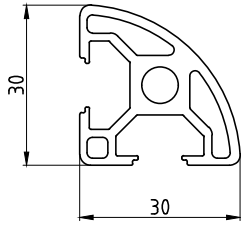

名称 Name	型号 Profile No.	壁厚 Thickness	单重(kg/m) Weight
支架	GYC46257	1.8	0.769

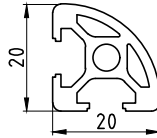

名称 Name	型号 Profile No.	壁厚 Thickness	单重(kg/m) Weight
流水线支架	GYC46389		0.452

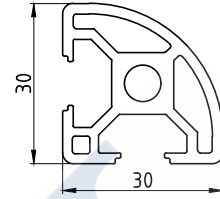

名称 Name	型号 Profile No.	壁厚 Thickness	单重(kg/m) Weight
流水线支架	GYC46392		0.867

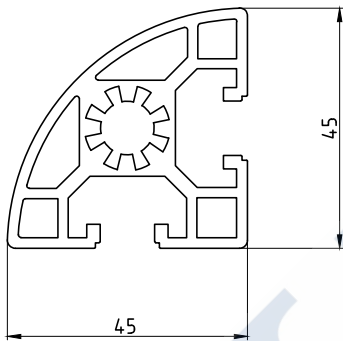

名称 Name	型号 Profile No.	壁厚 Thickness	单重(kg/m) Weight
支架	GYC46254	2.0	1.634

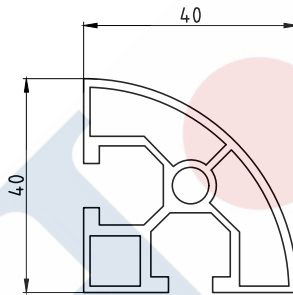

名称 Name	型号 Profile No.	壁厚 Thickness	单重(kg/m) Weight
支架	GYC46300	1.6	0.949

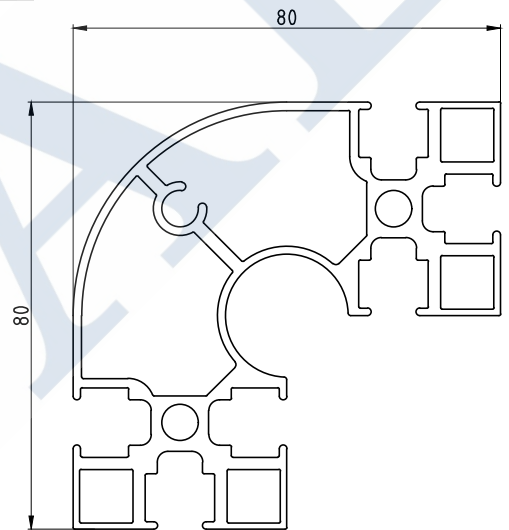

名称 Name	型号 Profile No.	壁厚 Thickness	单重(kg/m) Weight
支架	GYC-JZ067		2.778

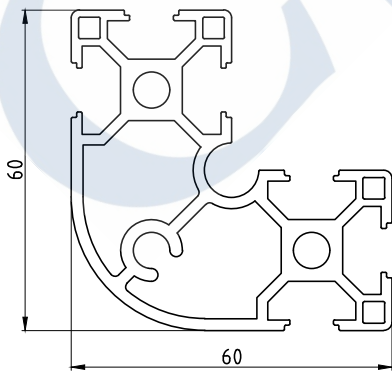

名称 Name	型号 Profile No.	壁厚 Thickness	单重(kg/m) Weight
支架	GYC46297	1.35	2.092

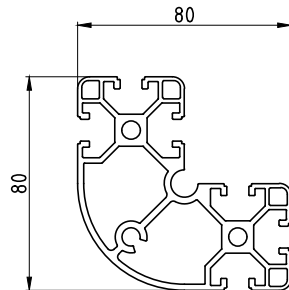

名称 Name	型号 Profile No.	壁厚 Thickness	单重(kg/m) Weight
支架	GYC46281	2.3	3.173

此型材比例为1:2

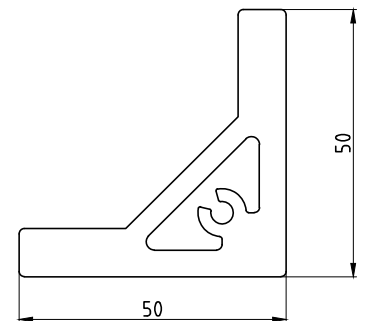

名称 Name	型号 Profile No.	壁厚 Thickness	单重(kg/m) Weight
流水线支架	GYC46372		2.294

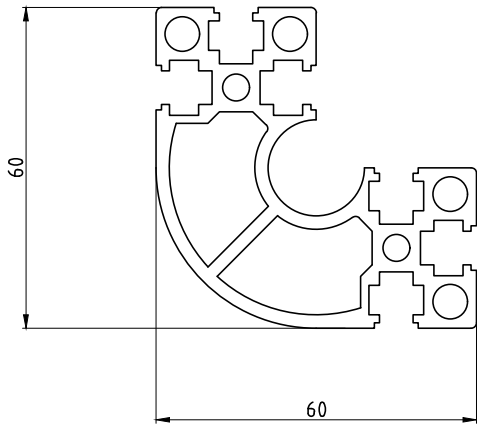

名称 Name	型号 Profile No.	壁厚 Thickness	单重(kg/m) Weight
支架	GYC-JZ117		2.274

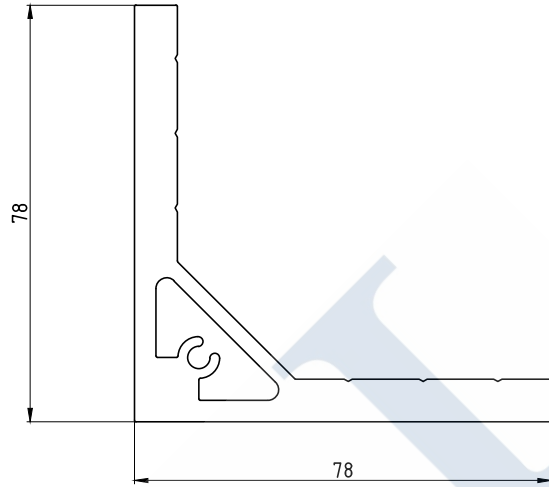

名称 Name	型号 Profile No.	壁厚 Thickness	单重(kg/m) Weight
流水线支架	GYC46373		3.203

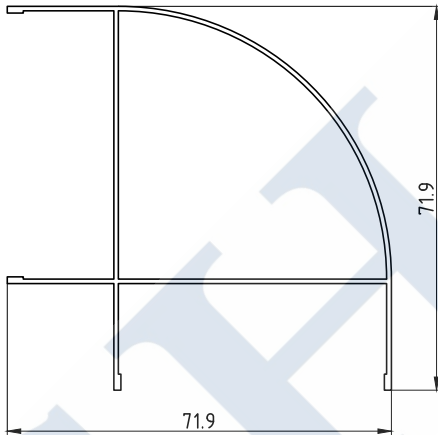

名称 Name	型号 Profile No.	壁厚 Thickness	单重(kg/m) Weight
转角	GYC-JZ091	0.85	0.618

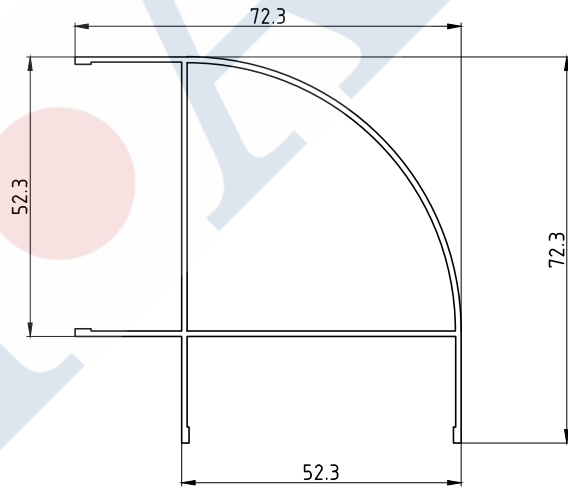

名称 Name	型号 Profile No.	壁厚 Thickness	单重(kg/m) Weight
转角	HJG-3893	1	0.753

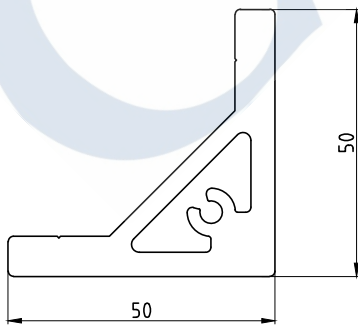

名称 Name	型号 Profile No.	壁厚 Thickness	单重(kg/m) Weight
支架料	GYC-JZ079		2.045

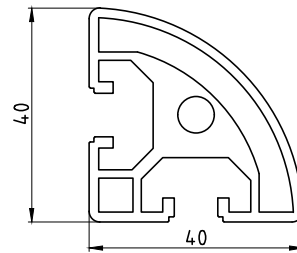

名称 Name	型号 Profile No.	壁厚 Thickness	单重(kg/m) Weight
流水线支架	GYC46384		1.363